

HEIKO SERVICE MANUAL

Model JZ035-Q2

WARNING

This service information is designed for experienced repair technicians only and is not designed for use by the general public. It does not contain warnings or cautions to advise non-technical individuals of potential dangers in attempting to service a product. Products powered by electricity should be serviced or repaired only by experienced professional technicians. Any attempt to service or Repair the product or products dealt with in this service information by anyone else could result in serious injury or death

2018 (Qingdao Haier Air Conditioner General corp. , Ltd)
All rights reserved. Unauthorized copying and distribution is a violation of law

Version: V1 **Date: 2023-02-21**

Contents

1. Introduction	1
2. Specifications.....	7
3. Sensors list	8
4. Piping diagrams	9
5. Operation range	10
6. Printed circuit board connector wiring diagram	11
7. Functions and control.....	15
8. Dimensional drawings.....	29
9. Center of gravity	29
10. Service diagnosis	30
11. Performance and curves diagrams.....	52
12. Circuit diagrams	60
13. Removal Procedure	62

1. Introduction

1.1 Model name explanation

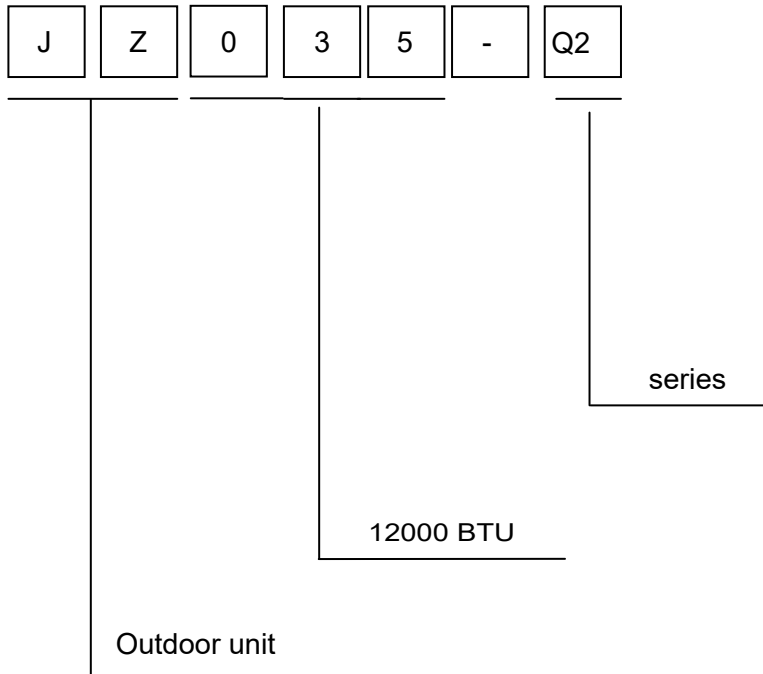

1.2 Safety Cautions

Be sure to read the following safety cautions before conducting repair work.

The caution items are classified into “Warning” and “Caution”. The “Warning” items are especially important since they can lead to death or serious injury if they are not followed closely. The “Caution” items can also lead to serious accidents under some conditions if they are not followed. Therefore, be sure to observe all the safety

caution items described below.

About the pictograms

△ This symbol indicates an item for which caution must be exercised.

The pictogram shows the item to which attention must be paid.

○ This symbol indicates a prohibited action.

The prohibited item or action is shown inside or near the symbol.

● This symbol indicates an action that must be taken, or an instruction.

The instruction is shown inside or near the symbol.

After the repair work is complete, be sure to conduct a test operation to ensure that the equipment operates Normally, and explain the cautions for operating the product to the customer.

1.2.1 Embedded wire checking before installation

Check the embedded wire diameter suitable to request:





(Power supply from indoor: 2.5kw $\geq 1.0\text{mm}^2$ 3.5kw,5kw $\geq 1.5\text{mm}^2$ 7kw $\geq 2.5\text{mm}^2$; Power supply from outdoor $\geq 1.0\text{mm}^2$)







Check the embedded wire are four roots, L/N/COM/GND; GND is needed, if not, thunder or high voltage wave from power grid will impact to the performance

Using a multi-meter to test short circuit of the four roots wires, make sure no short circuit happen.

1.2.2 Caution in Repair



Warning	
<p>Be sure to disconnect the power cable plug from the plug socket before disassembling the equipment for a repair.</p> <p>Working on the equipment that is connected to a power supply can cause an electrical shock.</p> <p>If it is necessary to supply power to the equipment to conduct the repair or inspecting the circuits, do not touch any electrically charged sections of the equipment.</p>	

<p>If the refrigerant gas discharges during the repair work, do not touch the discharging refrigerant gas .The refrigerant gas can cause frostbite.</p>	
<p>When disconnecting the suction or discharge pipe of the compressor at the welded section, release the refrigerant gas completely at a well-ventilated place first. If there is a gas remaining inside the compressor , the refrigerant gas or cooling machine oil discharges when the pipe is disconnected, and it can cause injury.</p>	
<p>If the refrigerant gas leaks during the repair work, ventilate the area. The refrigerant gas can generate toxic gases when it contacts flames.</p>	
<p>The step-up capacitor supplies high-voltage electricity to the electrical components of the outdoor unit. Be sure to discharge the capacitor completely before conducting repair work . A charged capacitor can cause an electrical shock.</p>	
<p>Do not start or stop the air conditioner operation by plugging or unplugging the power cable plug. Plugging or unplugging the power cable plug to operate the equipment can cause an electrical shock or fire.</p>	

Warning	
<p>Do not repair the electrical components with wet hands . Working on the equipment with wet hands can cause an electrical shock</p>	
<p>Do not clean the air conditioner by splashing water. Washing the unit with water can cause an electrical shock.</p>	
<p>Be sure to provide the grounding when repairing the equipment in a humid or wet place, to avoid electrical shock.</p>	
<p>Be sure to turn off the power switch and unplug the power cable when cleaning the equipment. The internal fan rotates at a high speed, and cause injury.</p>	
<p>Do not tilt the unit when removing it. The water inside the unit can spill and wet the furniture and floor.</p>	
<p>Be sure to check that the cooling cycle section has cooled down sufficiently before conducting repair work. Working on the unit when the cooling cycle section is hot can cause burns.</p>	
<p>Use the welder in a well-ventilated place. Using the welder in an enclosed room can cause oxygen deficiency.</p>	

1.2.3 Cautions Regarding Products after Repair



Warning	
Be sure to use parts listed in the service parts list of the applicable model and appropriate tools to conduct repair work. Never attempt to modify the equipment. The use of inappropriate parts or tools can cause an electrical shock, excessive heat generation or fire.	
When relocating the equipment, make sure that the new installation site has sufficient strength to withstand the weight of the equipment. If the installation site does not have sufficient strength and if the installation work is not conducted securely, the equipment can fall and cause injury.	
Be sure to install the product correctly by using the provided standard installation frame. Incorrect use of the installation frame and improper installation can cause the equipment to fall, resulting in injury.	For integral units only
Be sure to install the product securely in the installation frame mounted on a window frame. If the unit is not securely mounted, it can fall and cause injury.	For integral units only

Warning	
Be sure to use an exclusive power circuit for the equipment, and follow the technical standards related to the electrical equipment, the internal wiring regulations and the instruction manual for installation when conducting electrical work. Insufficient power circuit capacity and improper electrical work can cause an electrical shock or fire.	
Be sure to use the specified cable to connect between the indoor and outdoor units. Make the connections securely and route the cable properly so that there is no force pulling the cable at the connection terminals. Improper connections can cause excessive heat generation or fire.	
When connecting the cable between the indoor and outdoor units, make sure that the terminal cover does not lift off or dismount because of the cable. If the cover is not mounted properly, the terminal connection section can cause an electrical shock, excessive heat generation or fire.	
Do not damage or modify the power cable. Damaged or modified power cable can cause an electrical shock or fire. Placing heavy items on the power cable, and heating or pulling the power cable can damage the cable.	
Do not mix air or gas other than the specified refrigerant (R410A / R22) in the refrigerant system. If air enters the cooling system, an excessively high pressure results, causing equipment damage and injury.	
If the refrigerant gas leaks, be sure to locate the leak and repair it before charging the refrigerant. After charging refrigerant, make sure that there is no refrigerant leak. If the leak cannot be located and the repair work must be stopped, be sure to perform pump down and close the service valve, to prevent the refrigerant gas from leaking into the room. The refrigerant gas itself is harmless, but it can generate toxic gases when it contacts flames, such as fan and other heaters,	

stoves and ranges.	
When replacing the coin battery in the remote controller, be sure to disposed of the old battery to prevent children from swallowing it. If a child swallows the coin battery, see a doctor immediately.	

Caution	
Installation of a leakage breaker is necessary in some cases depending on the conditions of the installation site, to prevent electrical shocks.	
Do not install the equipment in a place where there is a possibility of combustible gas leaks. If a combustible gas leaks and remains around the unit, it can cause a fire.	
Be sure to install the packing and seal on the installation frame properly. If the packing and seal are not installed properly, water can enter the room and wet the furniture and floor.	

1.2.4 Inspection after Repair

Warning	
Check to make sure that the power cable plug is not dirty or loose, then insert the plug into a power outlet all the way. If the plug has dust or loose connection, it can cause an electrical shock or fire.	
If the power cable and lead wires have scratches or deteriorated, be sure to replace them. Damaged cable and wires can cause an electrical shock, excessive heat generation or fire.	





Warning	
Do not use a joined power cable or extension cable, or share the same power outlet with other electrical appliances since it can cause an electrical shock, excessive heat generation or fire.	

Caution	
Check to see if the parts and wires are mounted and connected properly, and if the connections at the soldered or crimped terminals are secure. Improper installation and connections can cause excessive heat generation, fire or an electrical shock.	
If the installation platform or frame has corroded, replace it. Corroded installation platform or frame can cause the unit to fall, resulting in injury.	
Check the grounding, and repair it if the equipment is not properly grounded. Improper grounding can cause an electrical shock.	
Be sure to measure the insulation resistance after the repair, and make sure that the resistance is 1 M ohm or higher. Faulty insulation can cause an electrical shock.	
Be sure to check the drainage of the indoor unit after the repair. Faulty drainage can cause the water to enter the room and wet the furniture and floor.	

1.2.5 Using Icons

Icons are used to attract the attention of the reader to specific information. The meaning of each icon is described in the table below:

1.2.6 Using Icons List

Icon	Type of Information	Description
 Note	Note	A “note” provides information that is not indispensable, but may nevertheless be valuable to the reader, such as tips and tricks.
 Caution	Caution	A “caution” is used when there is danger that the reader, through incorrect manipulation, may damage equipment, lose data, get an unexpected result or has to restart (part of) a procedure.
 Warning	Warning	A “warning” is used when there is danger of personal injury.
 Reference	Reference	A “reference” guides the reader to other places in this binder or in this manual, where he/she will find additional information on a specific topic.

2 .Specifications

NOMINAL DISTRIBUTION SYSTEM VOLTAGE		
Phase	/	1
Frequency	Hz	50
Voltage	V	220-240

NOMINAL CAPACITY and NOMINAL INPUT			
		cooling	heating
Capacity rated	KW	3.5 (0.8-3.6)	3.5(0.8-4.2)
	Btu/h	11940(2730-12286)	11940(2730-14330)
Power Consumption(Rated)	KW	1.21	0.94
SEER/SCOP	W/W	6.1	4.0
Annual energy consumption	KWh	201	980
Moisture Removal	m ³ /h	1.4*10 ⁻³	

TECHNICAL SPECIFICATIONS-UNIT			
Dimensions	H*W*D	mm	700×245×544
Packaged Dimensions	H*W*D	mm	845×320×593
Weight	/	KG	23.6
Gross weight	/	KG	26.1
Sound level	Sound pressure	dB(A)	50
	Sound power	dB(A)	63
			51
			64

ELECTRICAL SPECIFICATIONS			
		cooling	heating
Nominal running current	A	4.5	4.2
Maximum running current	A	7.1	7.1
Starting current	A	1.4	1.4

TECHNICAL SPECIFICATIONS-PARTS			
		cooling	heating
Compressor	Type	Rotary Compressor	
	Model	GSD102RKQA6JT6C	
	Motor output	W	990
	Oil type	ACS-68Ror equivalent	
	Oil charge volume	L	0.32
Fan	Type	Axial fan	
	Motor output	W	40
	Air flow rate(high)	m ³ /h	2100
	Speed(high/low)	rpm	850/300
Heat exchanger	Type	ML fin- φ 7HI-HX tube	
	Row*stage*fitch	1*14*1.4	

TECHNICAL SPECIFICATIONS-OTHERS			
Refrigerant circuit	Refrigerant type		R32
	Refrigerant charge		KG 0.53
	Maximum allowable distance between indoor an outdoor		m 20
	Maximum allowable level difference		m 10
	Refrigerant control		CAPILLARY
Piping connections (external diameter)	liquid	mm	Φ6.35
	gas	mm	Φ9.52
	drain	mm	Φ16
Heat insulation type		Both liquid and Gas pipes	
Max. piping Length		m	20
Max. vertical Difference		m	10
Chargeless		m	5
Amount of Additional Charge of Refrigerant		g/m	20
Intemational Protection degree		IP X4	

Note: the data are based on the conditions shown in the table below

cooling	heating	Piping length
Indoor: 27°CDB/19°CWB Outdoor: 35°CDB/24°CWB	Indoor:20°CDB Outdoor: 7°CDB/6°CWB	5m

Conversion formulae
Kcal/h= KW×860
Btu/h= KW×3414
cfm=m ³ /min×35.3

3. Sensors list

type	Description	Qty
Ambient sensor	Its used for detecting temperature of outdoor side	1
Defrosting sensor	Its used for controlling outdoor defrosting at heating mode	
Discharging sensor	Its used for compressor in case of over-heat	

4. Piping diagrams

Cooling mode

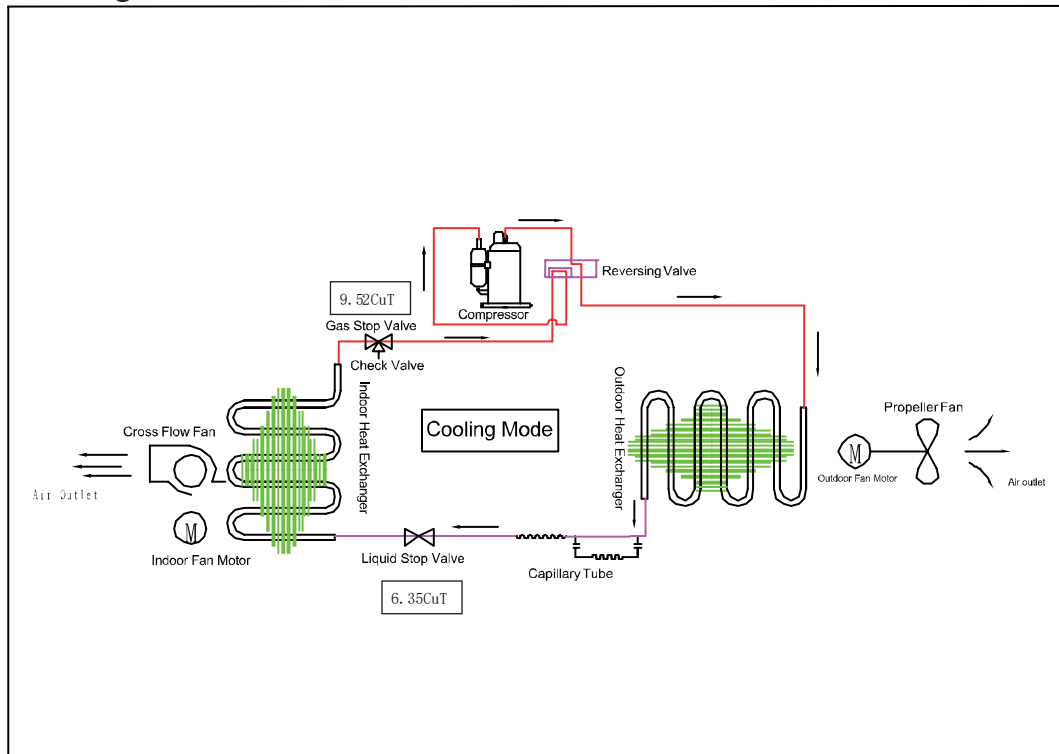

Heating mode

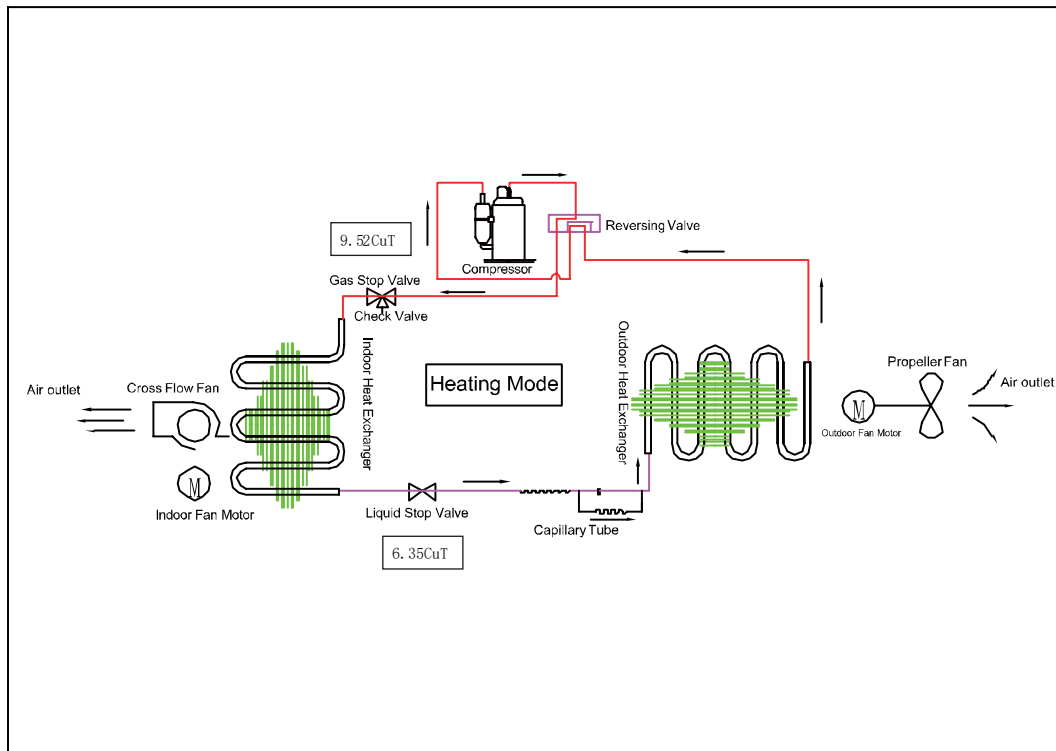

5.Operation range

The name of parts

Cooling

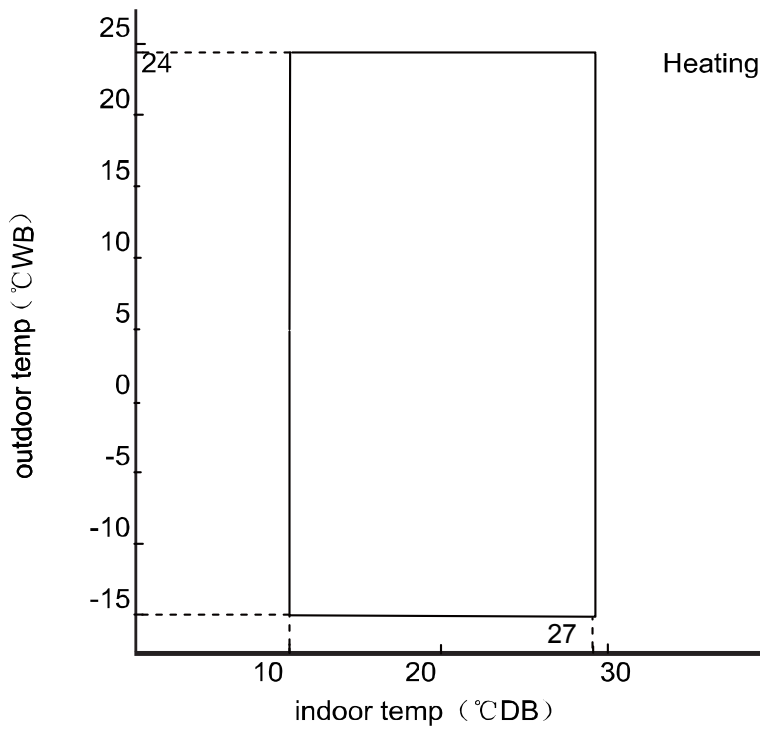
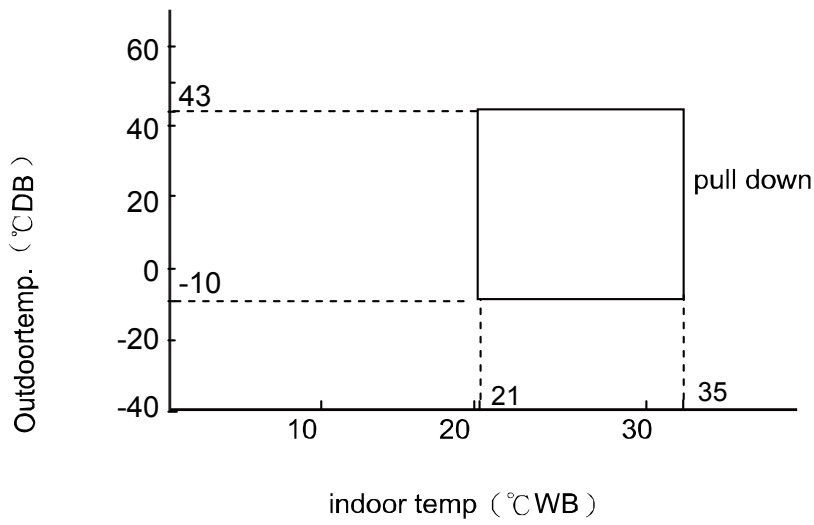

Notes:

The graphs are based on the following condition:

Equivalent piping length	5m
Level difference	0m
Air flow rate	high

6. Printed circuit board connector wiring diagram

PCB (Control PCB)

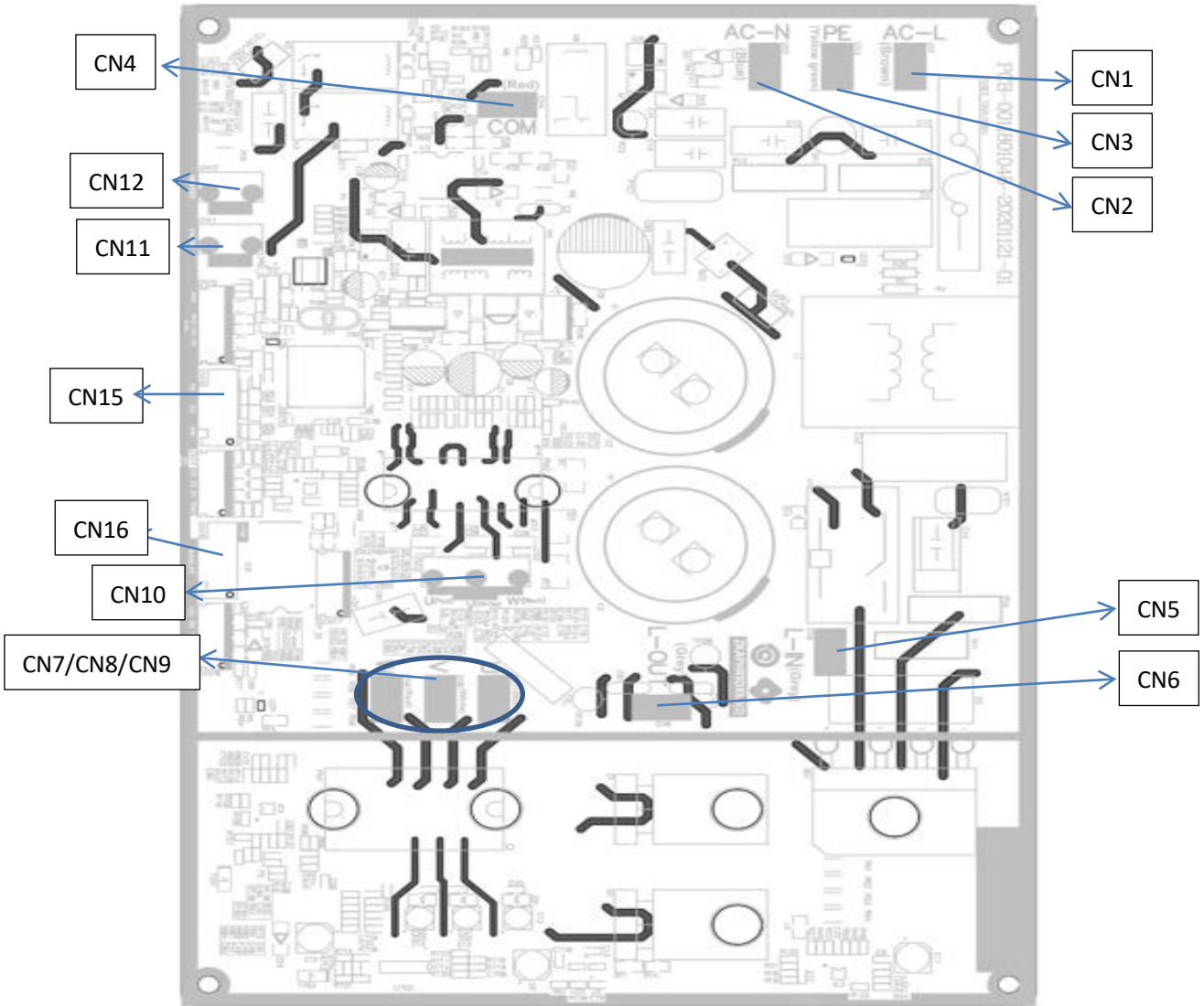

Wiring diagrams

OUTDOOR UNIT

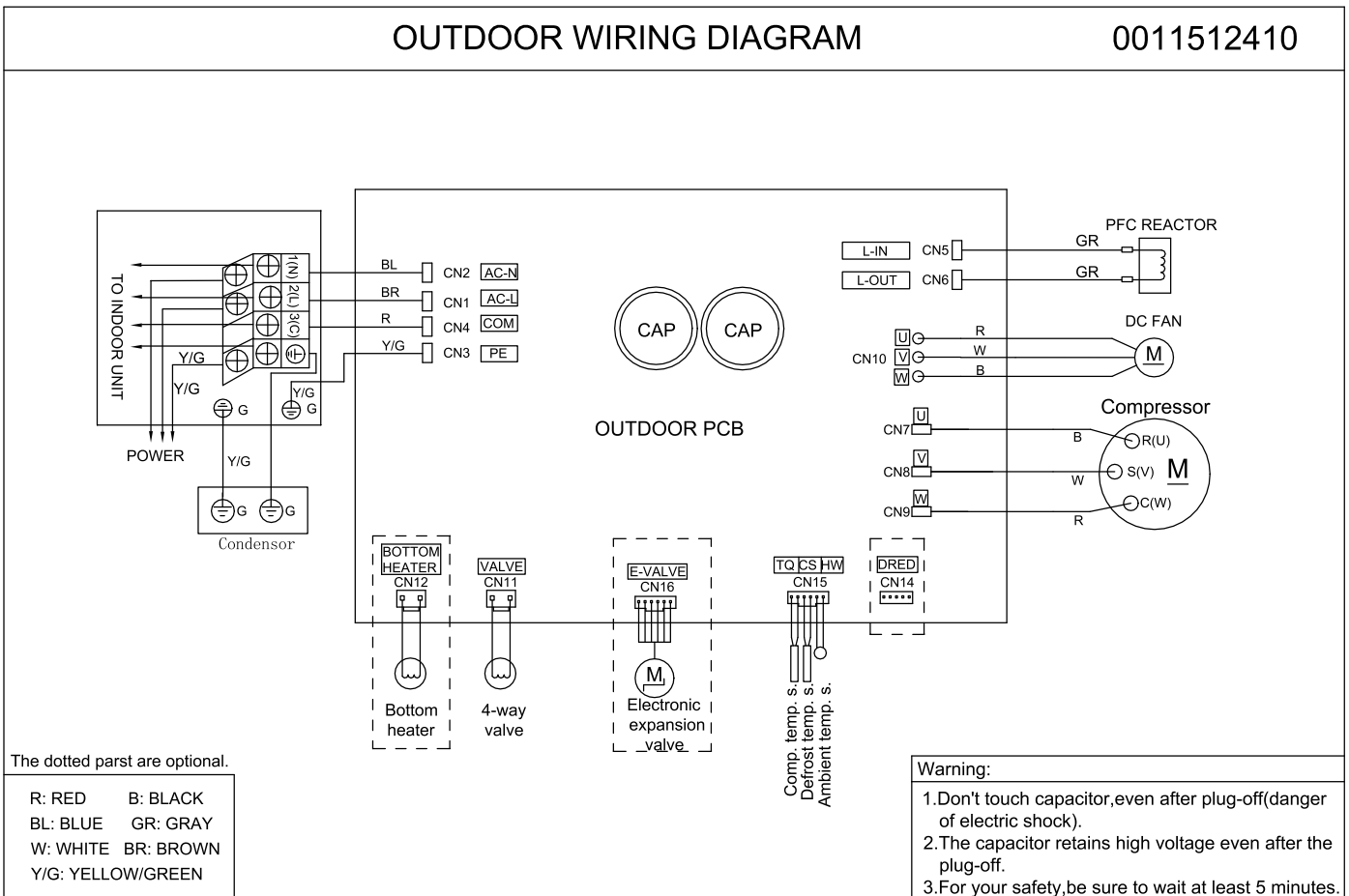

7. Functions and control

7.1 Main functions and control specification

7.1.1 The operation frequency of outdoor unit and its control

7.1.1.1 The operation frequency control of compressor

The operation frequency scope of compressor:

Mode	Minimum operation frequency	Maximum operation frequency
Heating (12K)	31Hz	75Hz
Refrigeration (12K)	31Hz	99 Hz

7.1.1.2 The starting of compressor

When the compressor is started for the first time, it must be kept under the conditions of 38Hz,58Hz,88Hz for 30second,one minute, one minute (the overheating protection of the outdoor unit air-blowing temperature, immediately decrease the frequency when the compressor is overflowing and releasing the pressure), then it can be operated towards the target frequency. When the machine runs normally, there's no such process. After starting the compressor for operation, the compressor should run according to the calculated frequency, and every determined frequency for protection should be prior to the calculated frequency.

7.1.1.3 The speeds of increasing or decreasing the frequency of the compressor

The speed of increasing or decreasing the frequency rapidly 1 -----1HZ/second

The speed of increasing or decreasing the frequency slowly 2 -----1HZ/10seconds

7.1.1.4 The calculation of the compressor's frequency

Refrigeration/dehumidification mode:

$$P_n = (N_h_c - S_c) * 10 \geq 50 \quad \text{outdoor environment control}$$

$$P_n = (N_h_c - S_c) * 10 < 50 \quad \text{PID control}$$

Heating mode:

$$P_n = (S_c - N_h_c) * 10 \geq 60 \quad \text{outdoor environment control}$$

$$P_n = (S_c - N_h_c) * 10 < 60 \quad \text{PID control}$$

(N_h_c =indoor environment temperature S_c =setting temperature)

1) The minimum/maximum frequency limitation

A. While refrigerating: F-MAX-r is the maximum operation frequency of the compressor; F-MIN-r is the minimum operation frequency of the compressor.

B. While heating: F-MAX-d is the maximum operation frequency of the compressor; F-MIN-d is the minimum operation frequency of the compressor.

2) The frequency limitation which is affected by the environment temperature.

(W_h_c = environment temperature)

Heating mode:

Serial No.	Temperature scope	Frequency limitation (12K)
1	$W_h_c < -12$	Max_hz1 99HZ
2	$W_h_c < -8$	Max_hz2 99HZ

3	Wh_c<-2	Max_hz3	99HZ
4	Wh_c<5	Max_hz4	91HZ
5	Wh_c<10	Max_hz5	76HZ
6	Wh_c<17	Max_hz6	69HZ
7	Wh_c<20	Max_hz7	59HZ
8	Wh_c>=20	Max_hz8	45HZ

Remarks: The above are the maximum frequency limitations of the complete appliance which are affected by the environment, and they have nothing to do with the ability of the indoor unit.

Refrigeration/dehumidification mode:

Serial No.	Temperature scope	Frequency limitation (12K)
1	Wh_c<16	Max_hz1 51HZ
2	Wh_c<22	Max_hz2 58Hz
3	Wh_c<29	Max_hz3 63HZ
4	Wh_c<32	Max_hz4 69Hz
5	Wh_c<40	Max_hz5 75Hz
6	Wh_c<48	Max_hz6 64Hz
7	Wh_c>=48	Max_hz7 45HZ

Remarks: the above are not only the maximum frequency limitations of the complete appliance which are affected by the environment, but also the maximum ability limitation of the system. When the starting ability is not the maximum, its maximum frequency limitation is calculated by the following equations:

The frequency limitation which is affected by the temperature and under the condition of actual ability=the actual running system ability*the maximum frequency which is limited by the temperature and under the condition of maximum ability/the maximum designing ability of the system

Refrigeration/dehumidification mode:

The indoor setting airflow speed	Low	Medium	Quiet
The percentage of the rated frequency K (09K)	70%	85%	50%

Heating mode:

The indoor setting airflow speed	Low	Medium	Quiet
The percentage of the rated frequency K (09K)	80%	90%	51%

The calculation of the actual output frequency:

$$F = F-ED \cdot (\text{rated frequency}) \times K$$

F-ED*(rated frequency)= The frequency which is limited by the outdoor environment temperature

Notes:

When refrigerating, it is needed to satisfy

$$F\text{-MIN-d}(\text{compressor's Min_hz}) < F < F\text{-MAX-d}(\text{compressor's Max_hz})$$

When heating, it is needed to satisfy

$$F\text{-MIN-r}(\text{compressor's Min_hz}) < F < F\text{-MAX-r}(\text{compressor's Max_hz})$$

PID control :

The initial frequency S_n is determined by P_n . We can calculate $H_z\text{outf}$ according to the value of $K_p, K_i, K_d, \text{Out_gain}, P_n$. Then, $F_n = S_n + H_z\text{outf}$. The value of F_n is calculated in each sample time (60 seconds), and F_n is adjusted according to previous frequency of S_n and filtered output of $H_z\text{outf}$.

7.1.2 The outdoor fan control (Exchange fan)

When the fan is changed among every airflow speed (including stop blowing), in order to avoid the airflow speed from skipping frequently, it must be kept under each mode for over 30 seconds, and then it can be changed to another mode (when refrigerating, the time is changed to 15 seconds).

7.1.2.1 The outdoor fan control

Within three minutes of compressor starting, the compressor is controlled according to the ambient temperature.

Tao (°C)	Tao <22°C	22°C < Tao <29°C	Tao ≥29°C
Refrigeration/dehumidification (12K)	400r/min	600r/min	760r/min
Tao (°C)	Tao <<10°C	10°C < Tao <17°C	Tao ≥17°C
Heating	800r/min	760r/min	400r/min

After 3 minutes, the compressor is controlled according to the ambient temperature and the frequency of the compressor.

Refrigeration/dehumidification frequency (Hz) 12 K		<41 Hz	41 Hz -62 Hz	≥62 Hz
Tao (°C)	≤22	400r/min	500r/min	600r/min
	22-29	500r/min	600r/min	760r/min
	≥29	760r/min		
Heating frequency (Hz) (12K)		<61 Hz	61-74 Hz	≥74 Hz
Tao (°C)	≤10	760r/min	760r/min	800r/min
	10-17	600r/min	760r/min	800r/min
	≥17	600r/min		

7.1.4 Four way control

For the details of defrosting four-way valve control, see the defrosting process.

Four way working in other ways:

Under the mode of heating, open the four-way valve, when the compressor is not started or changed to non-heating mode, make sure the compressor is stoped for 2 minutes, and then close the four-way valve.

7.1.5 Protection function

7.1.5.1 TTC high temperature-preventing protection

Once the machine is started, it can run TTC(air-blowing temp) overheating protection of air-blowing, but air-blowing sensor malfunction must alarm after 4 minutes during which the compressor is started (during the course of self-detection, there's no such limitation)

Sensor detection methods: 100 times (one cycle of procedure run is one time, and about 5ms, detection method for each time: continuously sampling for 8 times, then order them and take the mean value of the middle 2 values), take the mean value.

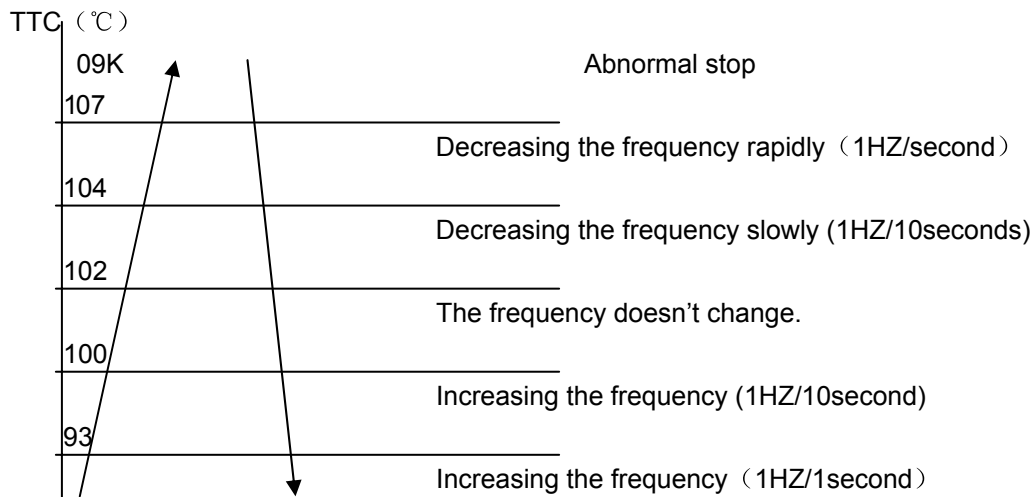

TTC \geq 110°C lasts for 20 seconds. Overheating protection of air-blowing, alarm malfunction to the indoor, others don't last.

7.1.5.2 TC high temperature-preventing control of the indoor heating unit:

Tpg_indoor is the highest value of the effective indoor unit (start it and it is in accord with the running state). TC=indoor coil temp.

The indoor heat exchanger sensor tests the temperature of the indoor heat exchanger. If the temperature is higher than 63°C, decrease the rotate speed of the compressor and do the high temperature-preventing protection of the indoor heat exchanger; if the temperature of the indoor heat exchanger is lower than 45°C, recover to the normal control.

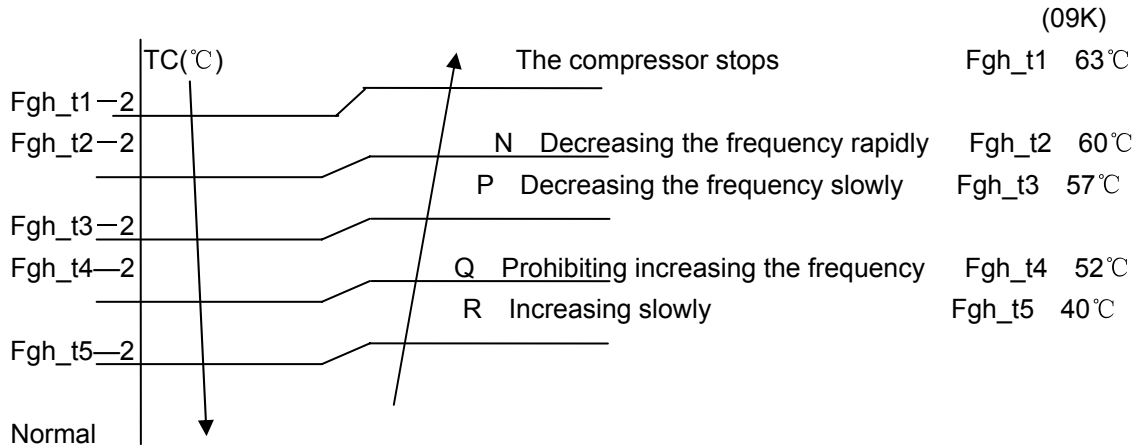

- N: Decreasing at the speed of 1HZ/1 second
- P: Decreasing at the speed of 1Hz/10 seconds
- Q: Continue to keep the last-time instruction cycle
- R: Increasing at the speed of 1Hz/10seconds

Remarks: the outdoor unit

7.1.5.3 The control of preventing the over current of the compressor:

- During the starting process of the compressor, if the current of the compressor is greater than 12.5A for 3 seconds, stop the compressor and alarm, after 3 minutes, start it again, if such state appears 3 times in 20 minutes, stop the compressor and alarm, and confirm the malfunction. Then continue to run it only after the power is off.
- During the starting process of the compressor, if the AC current is greater than 9A, the frequency of the compressor decreases at the speed of 1HZ/second.
- During the starting process of the compressor, if the AC current is greater than 8A, the frequency of the compressor decreases at the speed of 0.1HZ/second.
- During the starting process of the compressor, if the AC current is greater than 7.5A, the frequency of the compressor increases at the prohibited speed.
- During the starting process of the compressor, if the AC current is greater than 6.5A, the frequency of the compressor increases at the speed of no faster than 0.1HZ/second.

7.1.5.4 The protection function of AC current:

During the starting process of the compressor, if the AC current is greater than 12.5A for 3 seconds, stop the compressor and alarm, after 3 minutes, start it again, if such state appears 3 times in 20 minutes, stop the compressor and alarm, and confirm the malfunction. Then continue to run it only after the the power is off.

During the starting process of the compressor, if the AC current is greater than 9A, the frequency of the compressor decreases at the speed of 1HZ/second.

During the starting process of the compressor, if the AC current is greater than 8A, the frequency of

the compressor decreases at the speed of 0.1HZ/second.

During the starting process of the compressor, if the AC current is greater than 7.5A, the frequency of the compressor increases at the prohibited speed.

During the starting process of the compressor, if the AC current is greater than 6.5A, the frequency of the compressor increases at the speed of no faster than 0.1HZ/second.

Remarks: when the outdoor temperature is high, there's compensation for AC current protection.

(1) When the outdoor environment temperature is higher than 40°C, AC current protection value decreases by 2A/1A(09K/12K).

(2) When the outdoor environment temperature is higher than 50°C, AC current protection value decreases by 3A/2A(09K/12K).

7.1.5.5 Anti-freezing protection of the indoor heat exchanger

When refrigerating/heating, prevent freezing.

Tpg_indoor is the minimum value of the effective indoor unit (start it and it is in accord with the running state).

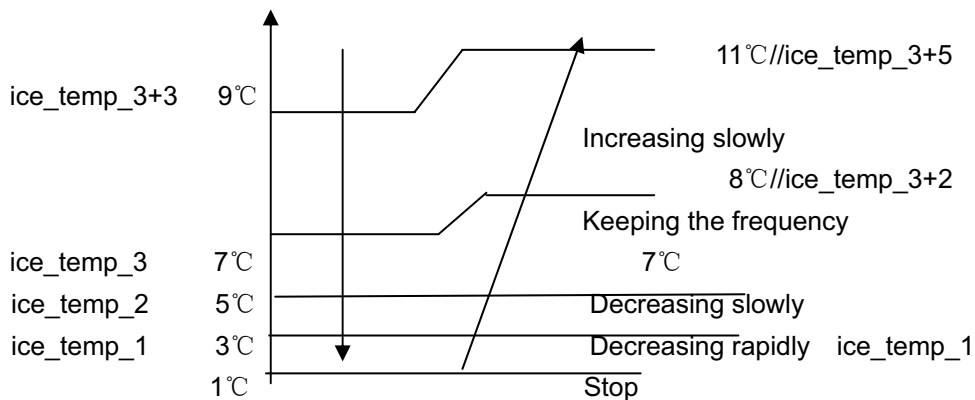

When $Tpg_indoor < ice_temp_1$, the frequency of the compressor decreases at the speed of 1HZ/1second.

When $Tpg_indoor < ice_temp_2$, the frequency of the compressor decreases at the speed of 1HZ/10seconds.

When Tpg_indoor begins to rise again, and $ice_temp_2 \leq Tpg_indoor \leq ice_temp_3$, the frequency of the compressor doesn't change.

When $ice_temp_3 < Tpg_indoor < ice_temp_3+3^\circ C$, the frequency of the compressor increases at the speed of 1HZ/10seconds.

For example, $Tpg_indoor \leq 0^\circ C$, last for 2 minutes, and then the outdoor unit will stop, and report underload malfunction, but don't send malfunction report to the indoor.

The compressor stops for more than 3 minutes, $Tpg_indoor > ice_temp_3+2^\circ C$, the compressor recovers.

7.1.5.6 The frequency limitation of modification rate

In the field which is controlled by high frequency, if the modification rate is not high enough, the control-driven chip will enter into weak magnetic control, this will help to relieve the problem of

modification rate. If during the course of weak magnetic control, the modification rate is still not high enough, enter into the control of decreasing frequency until the alarm of modification rate is relieved.

7.1.5.7 Temperature protection of the outdoor refrigerating coil

When the defrosting temperature and the sensor's temperature are higher than 68°C, the frequency of the compressor decreases 1hz/10seconds. Keep the frequency until it decreases to the lowest frequency. When the temperatures are lower than 68°C and higher than 62°C, keep the frequency of the compressor. When the temperatures are lower than 62°C, relieve the defrosting temperature protection.

7.2 Value of Thermistor

Ambient Sensor, Defrosting Sensor, Pipe sensor

R25°C=10KΩ ±3% B25°C/50°C=3700K±3%

Temp.(°C)	Max.(KΩ)	Normal(KΩ)	Min.(KΩ)	Tolerance(°C)	
-30	165.2170	147.9497	132.3678	-1.94	1.75
-29	155.5754	139.5600	125.0806	-1.93	1.74
-28	146.5609	131.7022	118.2434	-1.91	1.73
-27	138.1285	124.3392	111.8256	-1.89	1.71
-26	130.2371	117.4366	105.7989	-1.87	1.70
-25	122.8484	110.9627	100.1367	-1.85	1.69
-24	115.9272	104.8882	94.8149	-1.83	1.67
-23	109.4410	99.1858	89.8106	-1.81	1.66
-22	103.3598	93.8305	85.1031	-1.80	1.64
-21	97.6556	88.7989	80.6728	-1.78	1.63
-20	92.3028	84.0695	76.5017	-1.76	1.62
-19	87.2775	79.6222	72.5729	-1.74	1.60
-18	82.5577	75.4384	68.8710	-1.72	1.59
-17	78.1230	71.5010	65.3815	-1.70	1.57
-16	73.9543	67.7939	62.0907	-1.68	1.55
-15	70.0342	64.3023	58.9863	-1.66	1.54
-14	66.3463	61.0123	56.0565	-1.64	1.52
-13	62.8755	57.9110	53.2905	-1.62	1.51
-12	59.6076	54.9866	50.6781	-1.60	1.49
-11	56.5296	52.2278	48.2099	-1.58	1.47
-10	53.6294	49.6244	45.8771	-1.56	1.46
-9	50.8956	47.1666	43.6714	-1.54	1.44
-8	48.3178	44.8454	41.5851	-1.51	1.42
-7	45.8860	42.6525	39.6112	-1.49	1.40
-6	43.5912	40.5800	37.7429	-1.47	1.39
-5	41.4249	38.6207	35.9739	-1.45	1.37
-4	39.3792	36.7676	34.2983	-1.43	1.35
-3	37.4465	35.0144	32.7108	-1.41	1.33
-2	35.6202	33.3552	31.2062	-1.38	1.31

Functions and control

-1	33.8936	31.7844	29.7796	-1.36	1.29
0	32.2608	30.2968	28.4267	-1.34	1.28
1	30.7162	28.8875	27.1431	-1.32	1.26
2	29.2545	27.5519	25.9250	-1.29	1.24
3	27.8708	26.2858	24.7686	-1.27	1.22
4	26.5605	25.0851	23.6704	-1.25	1.20
5	25.3193	23.9462	22.6273	-1.23	1.18
6	24.1432	22.8656	21.6361	-1.20	1.16
7	23.0284	21.8398	20.6939	-1.18	1.14
8	21.9714	20.8659	19.7982	-1.15	1.12
9	20.9688	19.9409	18.9463	-1.13	1.09
10	20.0176	19.0621	18.1358	-1.11	1.07
11	19.1149	18.2270	17.3646	-1.08	1.05
12	18.2580	17.4331	16.6305	-1.06	1.03
13	17.4442	16.6782	15.9315	-1.03	1.01
14	16.6711	15.9601	15.2657	-1.01	0.99
15	15.9366	15.2770	14.6315	-0.98	0.96
16	15.2385	14.6268	14.0271	-0.96	0.94
17	14.5748	14.0079	13.4510	-0.93	0.92
18	13.9436	13.4185	12.9017	-0.91	0.90
19	13.3431	12.8572	12.3778	-0.88	0.87
20	12.7718	12.3223	11.8780	-0.86	0.85
21	12.2280	11.8126	11.4011	-0.83	0.83
22	11.7102	11.3267	10.9459	-0.81	0.80
23	11.2172	10.8634	10.5114	-0.78	0.78
24	10.7475	10.4216	10.0964	-0.75	0.75
25	10.3000	10.0000	9.7000	-0.75	0.75
26	9.8975	9.5974	9.2980	-0.76	0.76
27	9.5129	9.2132	8.9148	-0.80	0.80
28	9.1454	8.8465	8.5496	-0.84	0.83
29	8.7942	8.4964	8.2013	-0.87	0.86
30	8.4583	8.1621	7.8691	-0.91	0.90
31	8.1371	7.8428	7.5522	-0.95	0.93
32	7.8299	7.5377	7.2498	-0.98	0.97
33	7.5359	7.2461	6.9611	-1.02	1.00
34	7.2546	6.9673	6.6854	-1.06	1.04
35	6.9852	6.7008	6.4222	-1.10	1.07
36	6.7273	6.4459	6.1707	-1.13	1.11
37	6.4803	6.2021	5.9304	-1.17	1.14
38	6.2437	5.9687	5.7007	-1.21	1.18
39	6.0170	5.7454	5.4812	-1.25	1.22
40	5.7997	5.5316	5.2712	-1.29	1.25
41	5.5914	5.3269	5.0704	-1.33	1.29
42	5.3916	5.1308	4.8783	-1.37	1.33

Functions and control

43	5.2001	4.9430	4.6944	-1.41	1.36
44	5.0163	4.7630	4.5185	-1.45	1.40
45	4.8400	4.5905	4.3500	-1.49	1.44
46	4.6708	4.4252	4.1887	-1.53	1.47
47	4.5083	4.2666	4.0342	-1.57	1.51
48	4.3524	4.1145	3.8862	-1.61	1.55
49	4.2026	3.9686	3.7443	-1.65	1.59
50	4.0588	3.8287	3.6084	-1.70	1.62
51	3.9206	3.6943	3.4780	-1.74	1.66
52	3.7878	3.5654	3.3531	-1.78	1.70
53	3.6601	3.4416	3.2332	-1.82	1.74
54	3.5374	3.3227	3.1183	-1.87	1.78
55	3.4195	3.2085	3.0079	-1.91	1.82
56	3.3060	3.0989	2.9021	-1.95	1.85
57	3.1969	2.9935	2.8005	-2.00	1.89
58	3.0919	2.8922	2.7029	-2.04	1.93
59	2.9909	2.7948	2.6092	-2.08	1.97
60	2.8936	2.7012	2.5193	-2.13	2.01
61	2.8000	2.6112	2.4328	-2.17	2.05
62	2.7099	2.5246	2.3498	-2.22	2.09
63	2.6232	2.4413	2.2700	-2.26	2.13
64	2.5396	2.3611	2.1932	-2.31	2.17
65	2.4591	2.2840	2.1195	-2.36	2.21
66	2.3815	2.2098	2.0486	-2.40	2.25
67	2.3068	2.1383	1.9803	-2.45	2.29
68	2.2347	2.0695	1.9147	-2.49	2.34
69	2.1652	2.0032	1.8516	-2.54	2.38
70	2.0983	1.9393	1.7908	-2.59	2.42
71	2.0337	1.8778	1.7324	-2.63	2.46
72	1.9714	1.8186	1.6761	-2.68	2.50
73	1.9113	1.7614	1.6219	-2.73	2.54
74	1.8533	1.7064	1.5697	-2.78	2.58
75	1.7974	1.6533	1.5194	-2.83	2.63
76	1.7434	1.6021	1.4710	-2.88	2.67
77	1.6913	1.5528	1.4243	-2.92	2.71
78	1.6409	1.5051	1.3794	-2.97	2.75
79	1.5923	1.4592	1.3360	-3.02	2.80
80	1.5454	1.4149	1.2942	-3.07	2.84
81	1.5000	1.3721	1.2540	-3.12	2.88
82	1.4562	1.3308	1.2151	-3.17	2.93
83	1.4139	1.2910	1.1776	-3.22	2.97
84	1.3730	1.2525	1.1415	-3.27	3.01
85	1.3335	1.2153	1.1066	-3.32	3.06
86	1.2953	1.1794	1.0730	-3.38	3.10

Functions and control

87	1.2583	1.1448	1.0405	-3.43	3.15
88	1.2226	1.1113	1.0092	-3.48	3.19
89	1.1880	1.0789	0.9789	-3.53	3.24
90	1.1546	1.0476	0.9497	-3.58	3.28
91	1.1223	1.0174	0.9215	-3.64	3.33
92	1.0910	0.9882	0.8942	-3.69	3.37
93	1.0607	0.9599	0.8679	-3.74	3.42
94	1.0314	0.9326	0.8424	-3.80	3.46
95	1.0030	0.9061	0.8179	-3.85	3.51
96	0.9756	0.8806	0.7941	-3.90	3.55
97	0.9490	0.8558	0.7711	-3.96	3.60
98	0.9232	0.8319	0.7489	-4.01	3.64
99	0.8983	0.8088	0.7275	-4.07	3.69
100	0.8741	0.7863	0.7067	-4.12	3.74
101	0.8507	0.7646	0.6867	-4.18	3.78
102	0.8281	0.7436	0.6672	-4.23	3.83
103	0.8061	0.7233	0.6484	-4.29	3.88
104	0.7848	0.7036	0.6303	-4.34	3.92
105	0.7641	0.6845	0.6127	-4.40	3.97
106	0.7441	0.6661	0.5957	-4.46	4.02
107	0.7247	0.6482	0.5792	-4.51	4.07
108	0.7059	0.6308	0.5632	-4.57	4.12
109	0.6877	0.6140	0.5478	-4.63	4.16
110	0.6700	0.5977	0.5328	-4.69	4.21
111	0.6528	0.5820	0.5183	-4.74	4.26
112	0.6361	0.5667	0.5043	-4.80	4.31
113	0.6200	0.5518	0.4907	-4.86	4.36
114	0.6043	0.5374	0.4775	-4.92	4.41
115	0.5891	0.5235	0.4648	-4.98	4.45
116	0.5743	0.5100	0.4524	-5.04	4.50
117	0.5600	0.4968	0.4404	-5.10	4.55
118	0.5460	0.4841	0.4288	-5.16	4.60
119	0.5325	0.4717	0.4175	-5.22	4.65
120	0.5194	0.4597	0.4066	-5.28	4.70

Discharging Sensor

R80°C=50KΩ ±3%

B25/80°C=4450K±3%

Temp.((°C))	Max.(KΩ)	Normal(KΩ)	Min.(KΩ)	Tolerance(°C)	
-30	14646.0505	12061.7438	9924.4999	-2.96	2.45
-29	13654.1707	11267.8730	9290.2526	-2.95	2.44
-28	12735.8378	10531.3695	8700.6388	-2.93	2.44
-27	11885.1336	9847.7240	8152.2338	-2.92	2.43

Functions and control

-26	11096.6531	9212.8101	7641.8972	-2.91	2.42
-25	10365.4565	8622.8491	7166.7474	-2.90	2.42
-24	9687.0270	8074.3787	6724.1389	-2.88	2.41
-23	9057.2314	7564.2244	6311.6413	-2.87	2.41
-22	8472.2852	7089.4741	5927.0206	-2.86	2.40
-21	7928.7217	6647.4547	5568.2222	-2.84	2.39
-20	7423.3626	6235.7109	5233.3554	-2.83	2.39
-19	6953.2930	5851.9864	4920.6791	-2.82	2.38
-18	6515.8375	5494.2064	4628.5894	-2.80	2.37
-17	6108.5393	5160.4621	4355.6078	-2.79	2.37
-16	5729.1413	4848.9963	4100.3708	-2.77	2.36
-15	5375.5683	4558.1906	3861.6201	-2.76	2.35
-14	5045.9114	4286.5535	3638.1938	-2.75	2.34
-13	4738.4141	4032.7098	3429.0191	-2.73	2.34
-12	4451.4586	3795.3910	3233.1039	-2.72	2.33
-11	4183.5548	3573.4260	3049.5312	-2.70	2.32
-10	3933.3289	3365.7336	2877.4527	-2.69	2.31
-9	3699.5139	3171.3148	2716.0828	-2.67	2.30
-8	3480.9407	2989.2460	2564.6945	-2.66	2.29
-7	3276.5302	2818.6731	2422.6139	-2.64	2.28
-6	3085.2854	2658.8058	2289.2164	-2.63	2.28
-5	2906.2851	2508.9126	2163.9230	-2.61	2.27
-4	2738.6777	2368.3158	2046.1961	-2.60	2.26
-3	2581.6752	2236.3876	1935.5371	-2.58	2.25
-2	2434.5487	2112.5459	1831.4826	-2.56	2.24
-1	2296.6230	1996.2509	1733.6024	-2.55	2.23
0	2167.2730	1887.0018	1641.4966	-2.53	2.22
1	2045.9191	1784.3336	1554.7931	-2.52	2.21
2	1932.0242	1687.8144	1473.1460	-2.50	2.20
3	1825.0899	1597.0431	1396.2333	-2.48	2.19
4	1724.6540	1511.6468	1323.7551	-2.47	2.17
5	1630.2870	1431.2787	1255.4324	-2.45	2.16
6	1541.5904	1355.6163	1191.0048	-2.43	2.15
7	1458.1938	1284.3593	1130.2298	-2.41	2.14
8	1379.7528	1217.2282	1072.8813	-2.40	2.13
9	1305.9472	1153.9626	1018.7481	-2.38	2.12
10	1236.4792	1094.3200	967.6334	-2.36	2.11
11	1171.0715	1038.0743	919.3533	-2.35	2.09
12	1109.4661	985.0146	873.7359	-2.33	2.08
13	1051.4226	934.9440	830.6210	-2.31	2.07
14	996.7169	887.6792	789.8583	-2.29	2.06
15	945.1404	843.0486	751.3077	-2.27	2.04
16	896.4981	800.8922	714.8380	-2.26	2.03
17	850.6086	761.0603	680.3265	-2.24	2.02

Functions and control

18	807.3024	723.4134	647.6580	-2.22	2.00
19	766.4212	687.8205	616.7252	-2.20	1.99
20	727.8172	654.1596	587.4271	-2.18	1.98
21	691.3524	622.3161	559.6694	-2.16	1.96
22	656.8979	592.1831	533.3634	-2.14	1.95
23	624.3328	563.6604	508.4261	-2.12	1.93
24	593.5446	536.6540	484.7796	-2.10	1.92
25	564.4275	511.0760	462.3510	-2.09	1.90
26	536.9865	486.9352	441.1516	-2.07	1.89
27	511.0105	464.0500	421.0258	-2.05	1.87
28	486.4151	442.3499	401.9146	-2.03	1.86
29	463.1208	421.7683	383.7626	-2.01	1.84
30	441.0535	402.2430	366.5175	-1.99	1.83
31	420.1431	383.7151	350.1301	-1.97	1.81
32	400.3242	366.1295	334.5542	-1.95	1.80
33	381.5350	349.4341	319.7460	-1.93	1.78
34	363.7176	333.5801	305.6645	-1.90	1.76
35	346.8176	318.5216	292.2709	-1.88	1.75
36	330.7839	304.2151	279.5286	-1.86	1.73
37	315.5682	290.6199	267.4031	-1.84	1.71
38	301.1254	277.6976	255.8620	-1.82	1.70
39	287.4128	265.4119	244.8745	-1.80	1.68
40	274.3905	253.7288	234.4118	-1.78	1.66
41	262.0206	242.6161	224.4465	-1.76	1.64
42	250.2676	232.0436	214.9529	-1.74	1.63
43	239.0983	221.9825	205.9065	-1.71	1.61
44	228.4809	212.4060	197.2844	-1.69	1.59
45	218.3860	203.2887	189.0648	-1.67	1.57
46	208.7855	194.6066	181.2273	-1.65	1.55
47	199.6531	186.3369	173.7524	-1.63	1.54
48	190.9639	178.4584	166.6217	-1.60	1.52
49	182.6945	170.9508	159.8181	-1.58	1.50
50	174.8228	163.7951	153.3249	-1.56	1.48
51	167.3280	156.9733	147.1268	-1.53	1.46
52	160.1904	150.4683	141.2090	-1.51	1.44
53	153.3914	144.2641	135.5577	-1.49	1.42
54	146.9136	138.3454	130.1598	-1.47	1.40
55	140.7403	132.6980	125.0027	-1.44	1.38
56	134.8559	127.3081	120.0746	-1.42	1.36
57	129.2457	122.1630	115.3645	-1.40	1.34
58	123.8956	117.2504	110.8618	-1.37	1.32
59	118.7926	112.5589	106.5564	-1.35	1.30
60	113.9241	108.0776	102.4388	-1.32	1.28
61	109.2784	103.7961	98.5000	-1.30	1.26

Functions and control

62	104.8443	99.7046	94.7315	-1.28	1.23
63	100.6112	95.7939	91.1253	-1.25	1.21
64	96.5692	92.0553	87.6735	-1.23	1.19
65	92.7088	88.4805	84.3690	-1.20	1.17
66	89.0211	85.0614	81.2048	-1.18	1.15
67	85.4976	81.7908	78.1744	-1.15	1.12
68	82.1303	78.6615	75.2715	-1.13	1.10
69	78.9116	75.6668	72.4902	-1.10	1.08
70	75.8343	72.8004	69.8249	-1.08	1.06
71	72.8916	70.0561	67.2703	-1.05	1.03
72	70.0770	67.4283	64.8213	-1.03	1.01
73	67.3844	64.9115	62.4731	-1.00	0.99
74	64.8080	62.5006	60.2211	-0.98	0.96
75	62.3423	60.1906	58.0609	-0.95	0.94
76	59.9821	57.9770	55.9885	-0.92	0.92
77	57.7223	55.8552	53.9998	-0.90	0.89
78	55.5583	53.8210	52.0912	-0.87	0.87
79	53.4856	51.8706	50.2591	-0.85	0.84
80	51.5000	50.0000	48.5000	-0.85	0.84
81	49.7063	48.2057	46.7083	-0.85	0.85
82	47.9835	46.4842	44.9911	-0.89	0.89
83	46.3286	44.8323	43.3452	-0.93	0.92
84	44.7385	43.2468	41.7672	-0.96	0.95
85	43.2105	41.7248	40.2540	-1.00	0.99
86	41.7386	40.2604	38.7996	-1.03	1.02
87	40.3241	38.8545	37.4048	-1.07	1.06
88	38.9643	37.5045	36.0668	-1.11	1.09
89	37.6569	36.2078	34.7831	-1.14	1.13
90	36.3996	34.9622	33.5513	-1.18	1.16
91	35.1903	33.7653	32.3689	-1.22	1.19
92	34.0269	32.6151	31.2338	-1.26	1.23
93	32.9075	31.5096	30.1438	-1.30	1.27
94	31.8302	30.4467	29.0970	-1.33	1.30
95	30.7933	29.4246	28.0915	-1.37	1.34
96	29.7950	28.4417	27.1254	-1.41	1.37
97	28.8337	27.4961	26.1970	-1.45	1.41
98	27.9078	26.5864	25.3048	-1.49	1.44
99	27.0160	25.7110	24.4470	-1.53	1.48
100	26.1569	24.8685	23.6222	-1.57	1.52
101	25.3290	24.0574	22.8291	-1.61	1.55
102	24.5311	23.2765	22.0662	-1.65	1.59
103	23.7620	22.5245	21.3323	-1.69	1.63
104	23.0205	21.8002	20.6261	-1.73	1.66
105	22.3055	21.1025	19.9465	-1.77	1.70

Functions and control

106	21.6159	20.4303	19.2924	-1.81	1.74
107	20.9508	19.7825	18.6626	-1.85	1.77
108	20.3091	19.1582	18.0563	-1.89	1.81
109	19.6899	18.5564	17.4723	-1.93	1.85
110	19.0924	17.9761	16.9098	-1.98	1.89
111	18.5157	17.4166	16.3680	-2.02	1.93
112	17.9590	16.8769	15.8458	-2.06	1.96
113	17.4214	16.3564	15.3427	-2.10	2.00
114	16.9023	15.8542	14.8577	-2.15	2.04
115	16.4010	15.3696	14.3902	-2.19	2.08
116	15.9167	14.9020	13.9394	-2.23	2.12
117	15.4489	14.4506	13.5047	-2.27	2.16
118	14.9968	14.0149	13.0855	-2.32	2.19
119	14.5599	13.5942	12.6811	-2.36	2.23
120	14.1376	13.1879	12.2909	-2.41	2.27
121	13.7294	12.7955	11.9144	-2.45	2.31
122	13.3347	12.4165	11.5510	-2.50	2.35
123	12.9531	12.0503	11.2003	-2.54	2.39
124	12.5840	11.6965	10.8617	-2.58	2.43
125	12.2270	11.3545	10.5348	-2.63	2.47
126	11.8817	11.0240	10.2191	-2.68	2.51
127	11.5475	10.7046	9.9142	-2.72	2.55
128	11.2242	10.3957	9.6197	-2.77	2.59
129	10.9112	10.0970	9.3352	-2.81	2.63
130	10.6084	9.8082	9.0602	-2.86	2.67
131	10.3151	9.5288	8.7945	-2.91	2.71
132	10.0312	9.2586	8.5378	-2.95	2.75
133	9.7563	8.9971	8.2895	-3.00	2.80
134	9.4901	8.7441	8.0495	-3.05	2.84
135	9.2322	8.4993	7.8175	-3.09	2.88
136	8.9824	8.2623	7.5931	-3.14	2.92
137	8.7404	8.0329	7.3760	-3.19	2.96
138	8.5059	7.8108	7.1660	-3.24	3.00
139	8.2787	7.5958	6.9629	-3.29	3.04
140	8.0584	7.3875	6.7664	-3.33	3.09

8. Dimensional drawings

unit:mm

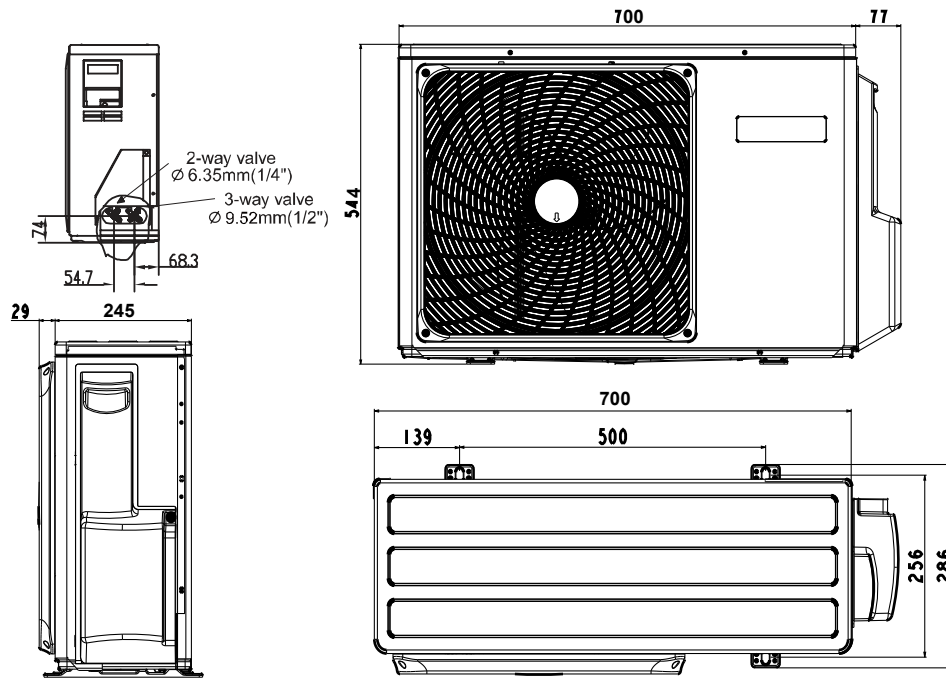

unit:mm

9. Center of gravity

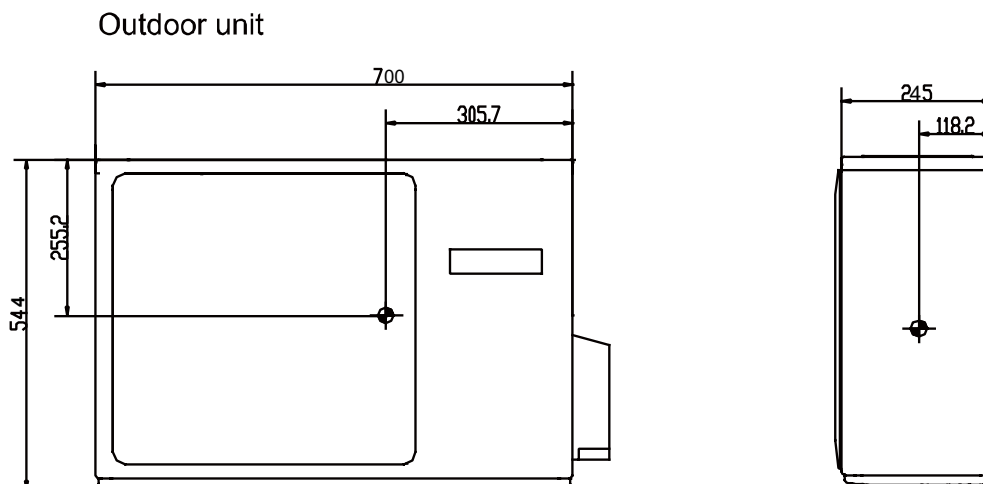

10 Service Diagnosis

10.1 Caution for Diagnosis

The operation lamp flashes when any of the following errors is detected.

1. When a protection device of the indoor or outdoor unit is activated or when the thermistor malfunctions, disabling equipment operation.
2. When a signal transmission error occurs between the indoor and outdoor units. In either case, conduct the diagnostic procedure described in the following pages.

10.2 Problem Symptoms and Measures

Symptom	Check Item	Details of Measure
None of the units operates	Check the power supply.	Check to make sure that the rated voltage is supplied.
	Check the indoor PCB	Check to make sure that the indoor PCB is broken
Operation sometimes stops.	Check the power supply.	A power failure of 2 to 10 cycles can stop air conditioner operation.
Equipment operates but does not cool, or does not heat (only for heat pump)	Check for faulty operation of the electronic expansion valve.	Set the units to cooling operation, and compare the temperatures of the liquid side connection pipes of the connection section among rooms to check the opening and closing operation of the electronic expansion valves of the individual units.
	Diagnosis by service port pressure and operating current.	Check for insufficient gas.
Large operating noise and vibrations	Check the installation condition.	Check to make sure that the required spaces for installation (specified in the Technical Guide, etc.) are provided.

10.3 Parameter of primary electronic appliance

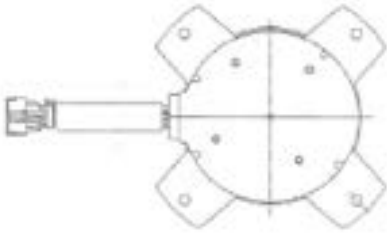
NO	Name	Parameter	Picture
1	Fan motor	Rated voltage: 220-230V Rated current: 0.2A Rated frequency: 50/60HZ	

10.4 Error Codes and Description indoor display

Split board: LED1 light of outdoor PCB flash; All-in-one board: LED2 light of outdoor PCB flash

ERROR CODE		OUTDOOR (LED FLASH TIMES)	FAULT DESCRIPTION	SPARE PART
Indoor and Outdoor	E7	15	Communication fault between indoor and outdoor units	Indoor PCB
				Outdoor PCB
				Power module
				Communication wiring
Indoor Malfunction	E1	/	Indoor temperature sensor failure	Room temperature sensor
				Indoor PCB
	E2	/	pipe temperature sensor failure	pipe temperature sensor
				Indoor PCB
	E4	/	Indoor EEPROM failure	Indoor PCB
	E5	22	Indoor anti-frosting protection	pipe temperature sensor
				Indoor PCB
				Indoor motor
	E9	21	Indoor unit overload in heating mode	pipe temperature sensor
				Indoor PCB
Indoor motor				
E14	/	Indoor fan motor malfunction	Indoor motor	
			Indoor PCB	
Outdoor Malfunction	F1	2	IPM protection	Power module
				Refrigerant
	F2	24	Instantaneous over-current protection of the compressor	Power module
				Refrigerant
				compressor
	F3	4	Communication error between Power module and main PCB board.	Power module
				Outdoor PCB
	F4	8	Compressor discharging temperature protection	Outdoor PCB
				discharge sensor
	F6	12	outdoor ambient sensor failure	outdoor ambient sensor
	F7	11	Suction temperature sensor failure	Suction temperature sensor
				outdoor PCB
F8	9	DC fan motor malfunction	outdoor PCB	
			outdoor motor	
F9	26	Module reset	Power module	
			Outdoor PCB	
			compressor	
F11	18	Loss of synchronism detection	The wiring of compressor	
			compressor	
			Power module	
F12	1	EEPROM failure	Outdoor PCB	

ERROR CODE		OUTDOOR (LED FLASH TIMES)	FAULT DESCRIPTION	SPARE PART
Outdoor Malfunction	F13	16	Lack of refrigerant	Refrigerant
	F14	17	4-way valve reverse failure	4-way valve
	F19	6	Power over/under voltage protection	Power module
	F20	5	High pressure protection	Outdoor pipe temperature sensor
				Outdoor PCB
	F21	10	Outdoor coil temperature sensor	Defrost temperature sensor
	F22	3	Outdoor Alternating current over current protection	Power module
				Refrigerant
				compressor
	F23	25	Compressor U-phase overcurrent Compressor V-phase overcurrent Compressor W-phase overcurrent	Power module
				Refrigerant
				compressor
	F24	27	CT detection current abnormal protection	Power module
				Compressor
	F25	13	Abnormal of compressor discharge sensor	discharge sensor
Outdoor PCB				
F27	7	Compressor current sampling circuit fault	Power module	
			Outdoor PCB	
			compressor	
F28	19	Compressor position detection circuit fault	Power module	
			Outdoor PCB	
			compressor	
F35	38	Compressor driver board failure	Power module	
			Outdoor PCB	
			Compressor	
F43	46	Model matching abnormality	/	
Fixed frequency AC	FE	/	Refrigerant leaking detection malfunction	Refrigerant

10.4.1 Thermistor or Related Abnormality

Indoor Display	E1: Room temperature sensor failure E2: Heat-exchange sensor failure
Outdoor display	LED1 flash 10 times : Defrost temperature sensor failure LED1 flash 11 times : Suction temperature sensor failure LED1 flash 12 times : Ambient temperature sensor failure LED1 flash 13 times ; Discharge temperature sensor failure

Method of Malfunction Detection

The temperatures detected by the thermistors are used to determine thermistor errors

Malfunction Decision Conditions

When the thermistor input is more than 4.92V or less than 0.08V during compressor operation.

- Note: The values vary slightly in some models

Supposed Causes

- Faulty connector connection
- Faulty thermistor
- Faulty PCB

Trouble shooting

* Caution: Be sure to turn off power switch before connect or disconnect connector, or else parts damage may be occurred.

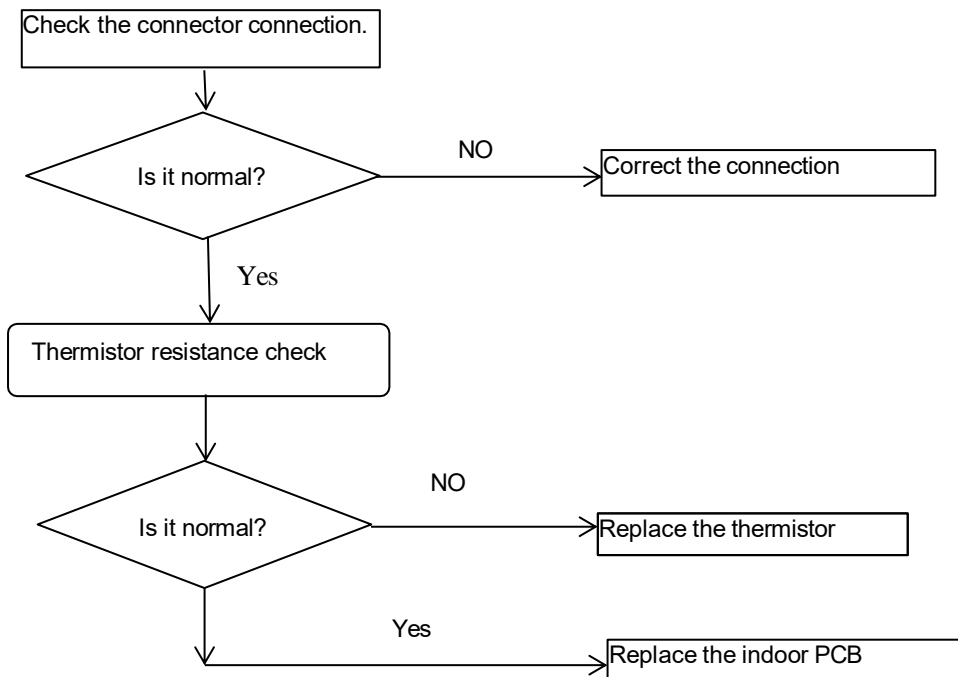

Thermistor resistance inspection method:

Remove the connector of the thermistor on the PCB, and measure the resistance of thermistor using tester. The relationship between normal temperature and resistance is shown in the value of indoor thermistor.

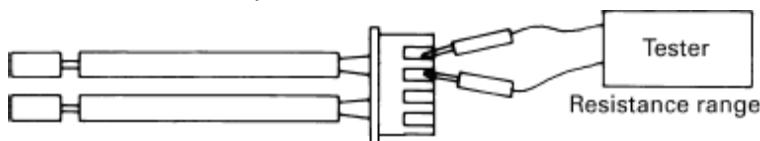

10.4.2 EEPROM abnormal

Indoor Display
Indoor display

E4: Indoor EEPROM error
F12: Outdoor EEPROM error; Outdoor LED1 flash 1 times

Method of
Malfunction
Detection

The Data detected by the EEPROM are used to determine MCU

Malfunction
Decision
Conditions

When the data of EEPROM is error or the EEPROM is damaged

Supposed
Causes

- Faulty EEPROM data
- Faulty EEPROM
- Faulty PCB

Trouble
shooting

* Caution: Be sure to turn off power switch before connect or disconnect connector, or parts damage may be occurred.

Replace the indoor or outdoor mainboard.

10.4.3 Indoor DC fan motor malfunction

Indoor Display

E14 Indoor DC fan motor malfunction

Method of Malfunction Detection

When the fan motor is running, the speed detected by the Hall IC is used to judge the abnormal operation of the fan motor

Malfunction Decision Conditions

When the detected rotation feedback signal don't received in 2 minutes

Supposed Causes

- Operation halt due to breaking of wire inside the fan motor.
- Operation halt due to breaking of the fan motor lead wires
- Detection error due to faulty indoor unit PCB

Trouble shooting

* Caution: Be sure to turn off power switch before connect or disconnect connector, or else parts damage may be occurred.

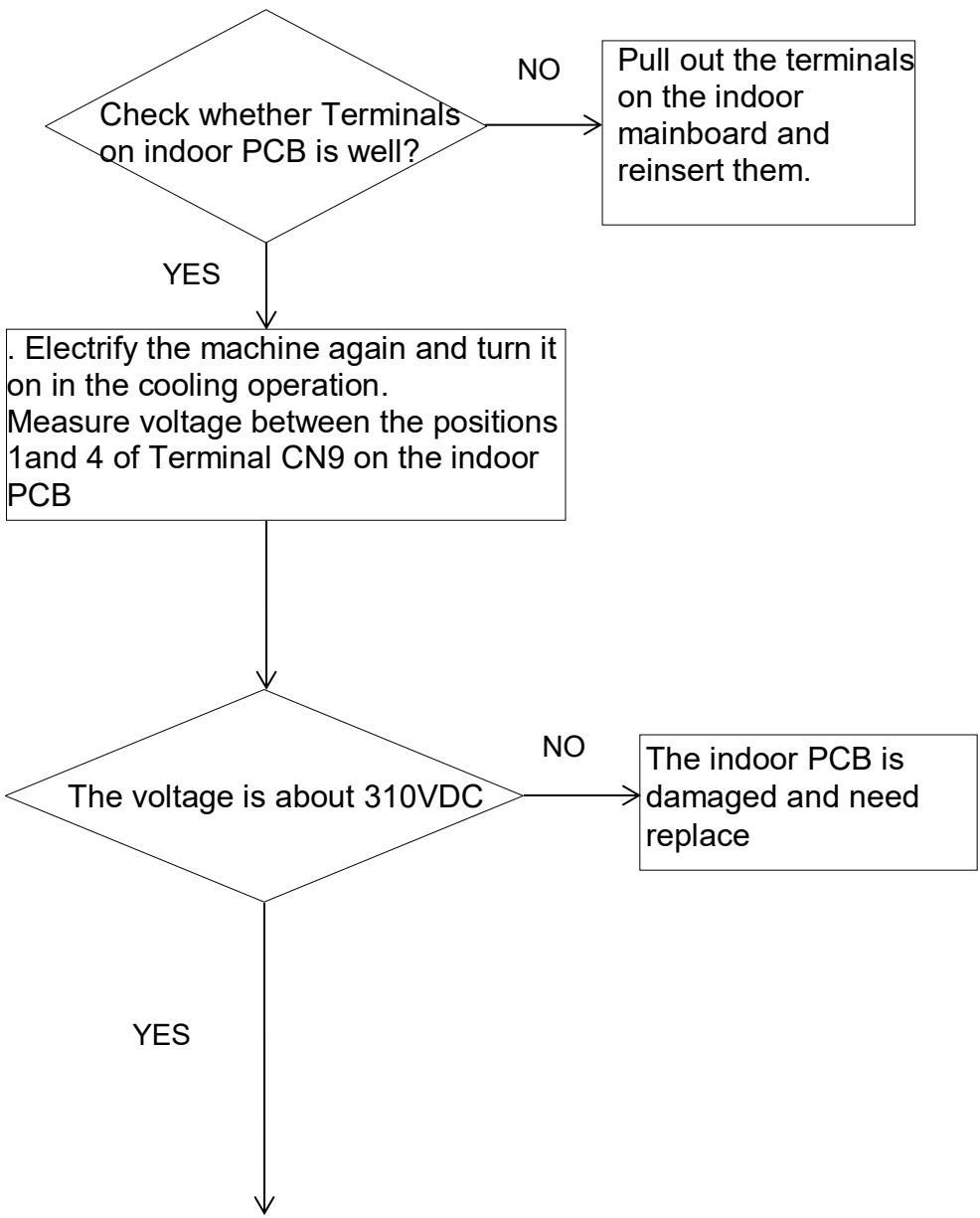

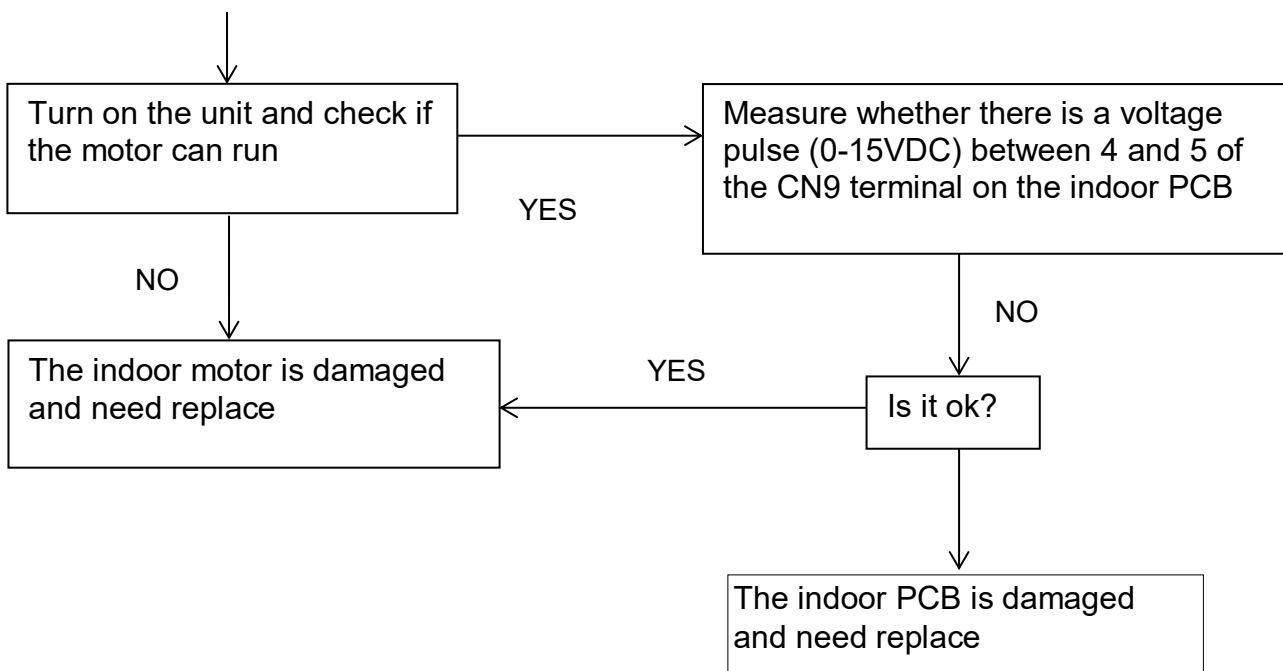

	Color	Signal	Voltage
1	Red	VDC	310V
2	---	---	---
3	---	---	---
4	Black	GND	0V
5	White	VCC	15v
6	Blue	FG	15V
7	Yellow	Vsp	0-6.5V



10.4.4 Outdoor DC fan motor fault

Outdoor display F8 LED1 flash 9 times

Method of Malfunction Detection

DC fan motor is detected by checking the fan running condition and so on

Malfunction Decision Conditions

When the detected rotation feedback signal don't received in 2 minutes

Supposed Causes

- DC fan motor protection dues to the DC fan motor faulty
- DC fan motor protection dues to faulty PCB

Trouble shooting

* Caution: Be sure to turn off power switch before connect or disconnect connector, or else parts damage may be occurred.

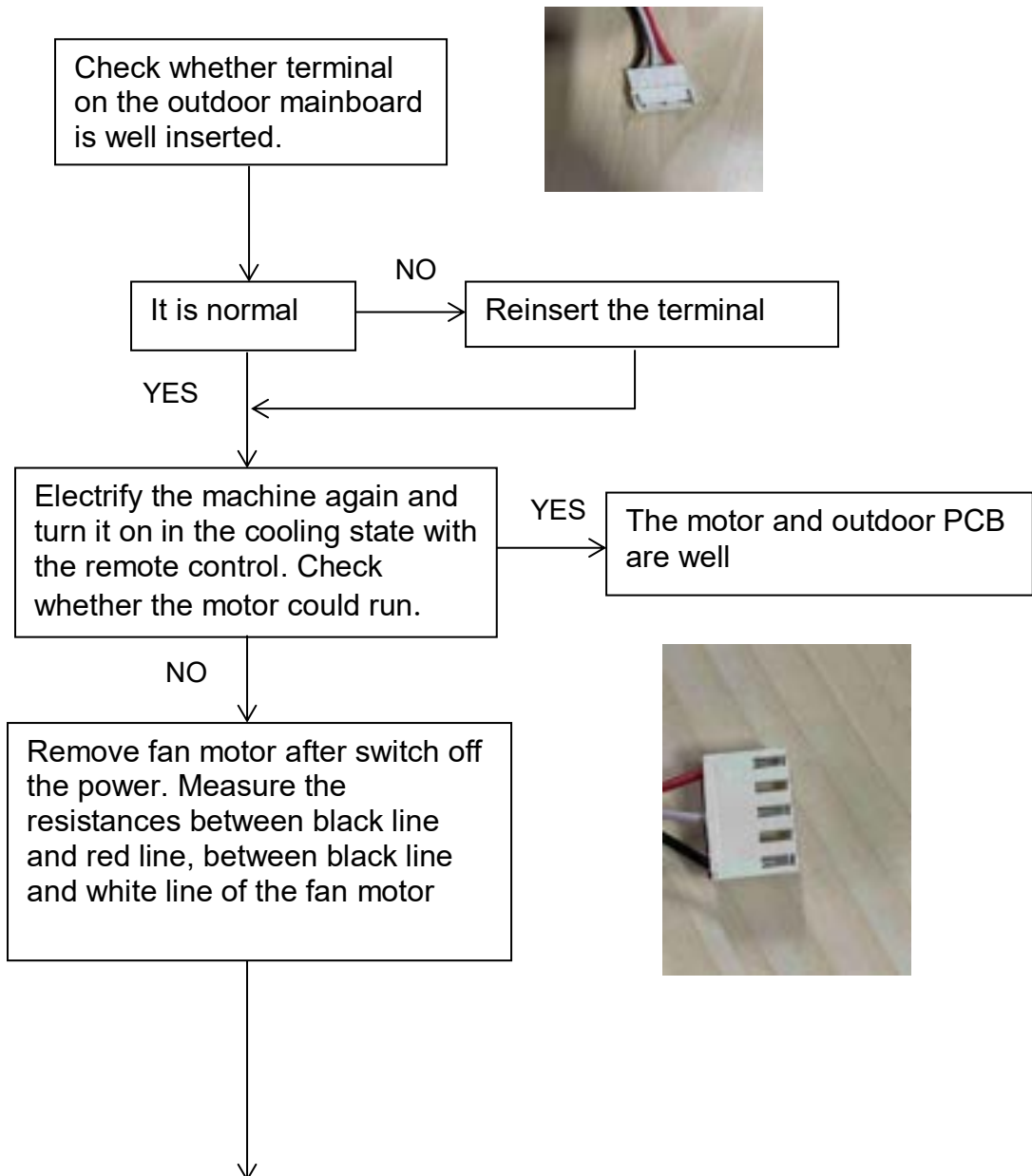

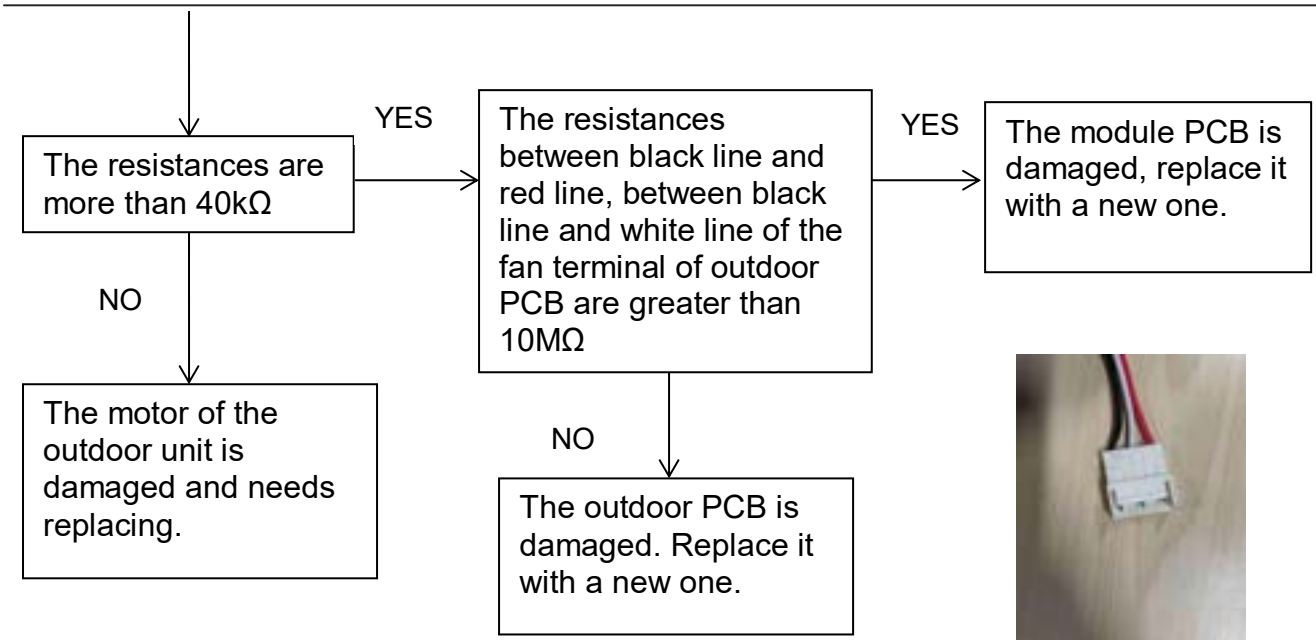

10.4.5 IPM protection

Outdoor display: F1 LED1 flash 2 times

Method of Malfunction Detection	IPM protection is detected by checking the compressor running condition and so on
Malfunction Decision Conditions	The system leads to IPM protection due to over current The compressor faulty leads to IPM protection Circuit component of IPM is broken and led to IPM protection
Supposed Causes	<ul style="list-style-type: none"> ■ IPM protection dues to the compressor faulty ■ IPM protection dues to faulty PCB of IPM module ■ Compressor wiring disconnected
Trouble shooting	* Caution: Be sure to turn off power switch before connect or disconnect connector, or else parts damage may be occurred

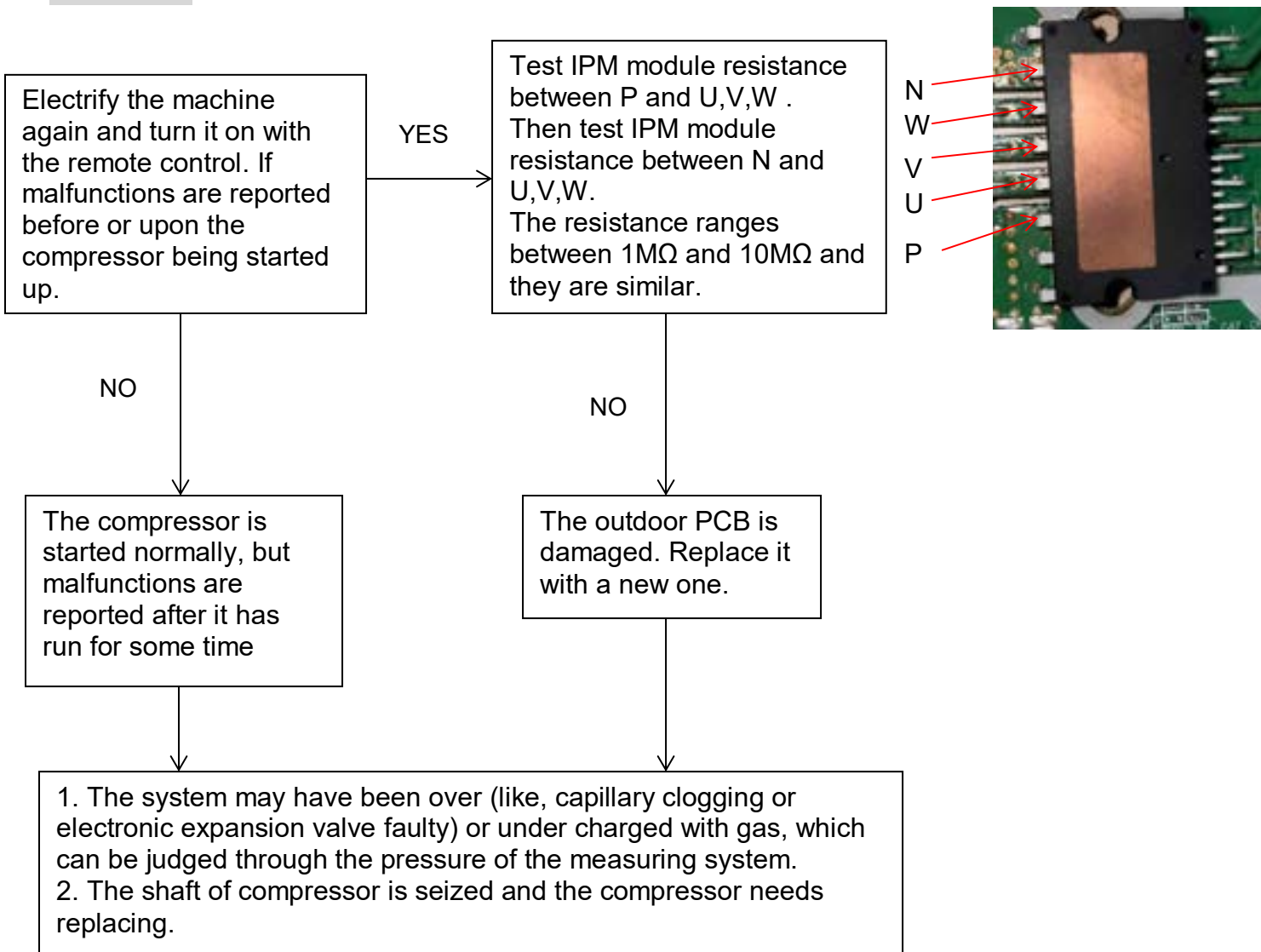

10.4.6 Over-current of the compressor

Outdoor Display F22, F2, F23 LED1 flash 3 or 24 or 25 times

Method of Malfunction Detection	The current of the compressor is too high
Malfunction Decision Conditions	When the IPM Module is damaged or the compressor is damaged. Power supply voltage is too low or too high
Supposed Causes	<ul style="list-style-type: none"> ■ Faulty IPM Module ■ Faulty compressor ■ Faulty power supply
Trouble shooting	* Caution: Be sure to turn off power switch before connect or disconnect connector, or parts damage may be occurred.

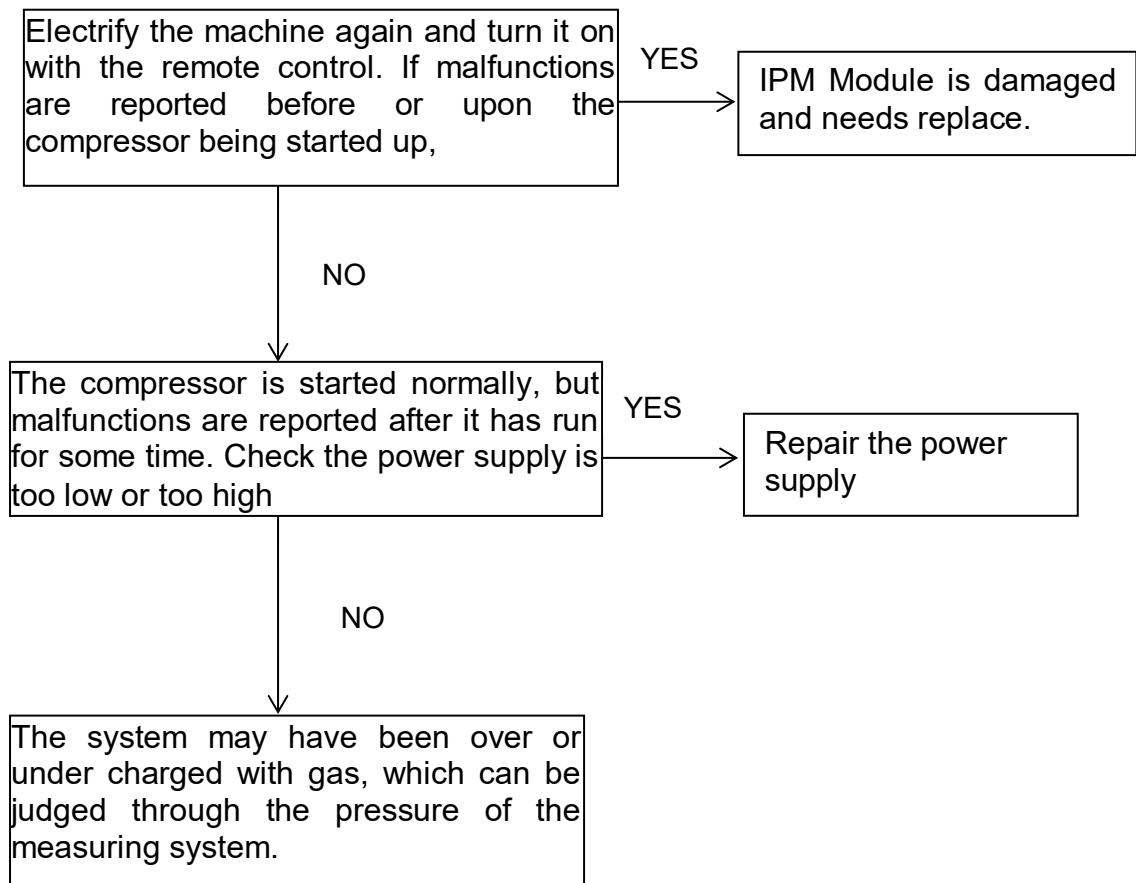

10.4.7 The communication fault between IPM and outdoor PCB

Outdoor display:	F3 LED1 flash 4 times
Method of Malfunction Detection	Communication is detected by checking the IPM module and the outdoor PCB
Malfunction Decision Conditions	<ul style="list-style-type: none"> ■ The outdoor PCB broken leads to communication fault ■ The IPM module broken leads to communication fault
Supposed Causes	<ul style="list-style-type: none"> ■ The outdoor PCB is broken ■ The IPM module is broken ■ Communication wiring disconnected
Trouble shooting	* Caution: Be sure to turn off power switch before connect or disconnect connector, or else parts damage may be occurred.

Check whether the CN23 and CN24 terminals of the outdoor PCB and the CN10 and CN11 terminals of the IPM module are tightly connected.
 Check whether the connection between the power module and the outdoor P&N line is tight

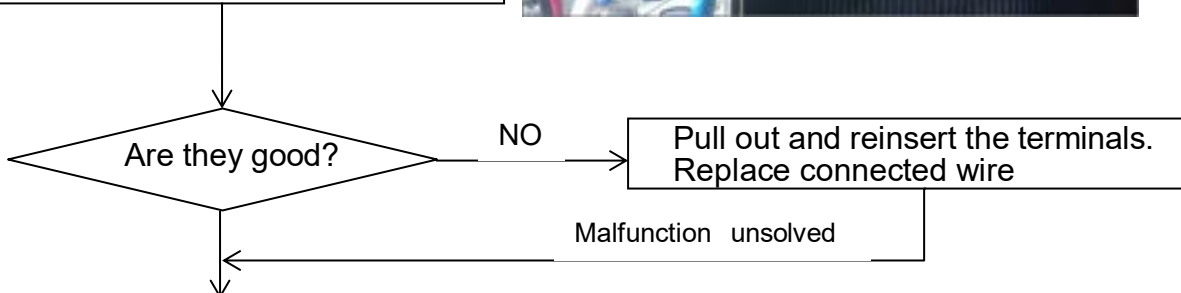

Electrify the machine again and turn it on.
 Check whether the voltage between 1 and 2 of Terminal CN23 is about DC5V.
 Check whether the voltage between 2 and 3 of terminal CN23 is about DC15V.

Replace the outdoor IPM module with a new one.

Replace the outdoor PCB with a new one



10.4.8 Power Supply Over or under voltage fault

Outdoor display: F19 LED1 flash 6 times

Method of Malfunction Detection
An abnormal voltage rise or fall is detected by checking the specified voltage detection circuit. The power supply is over voltage

Malfunction Decision Conditions
The voltage signal is fed from the voltage detection circuit to the microcomputer

- Supposed Causes**
- Supply voltage not as specified
 - the IPM module is broken
 - the outdoor PCB is broken

Trouble shooting
* Caution: Be sure to turn off power switch before connect or disconnect connector, or else parts damage may be occurred.

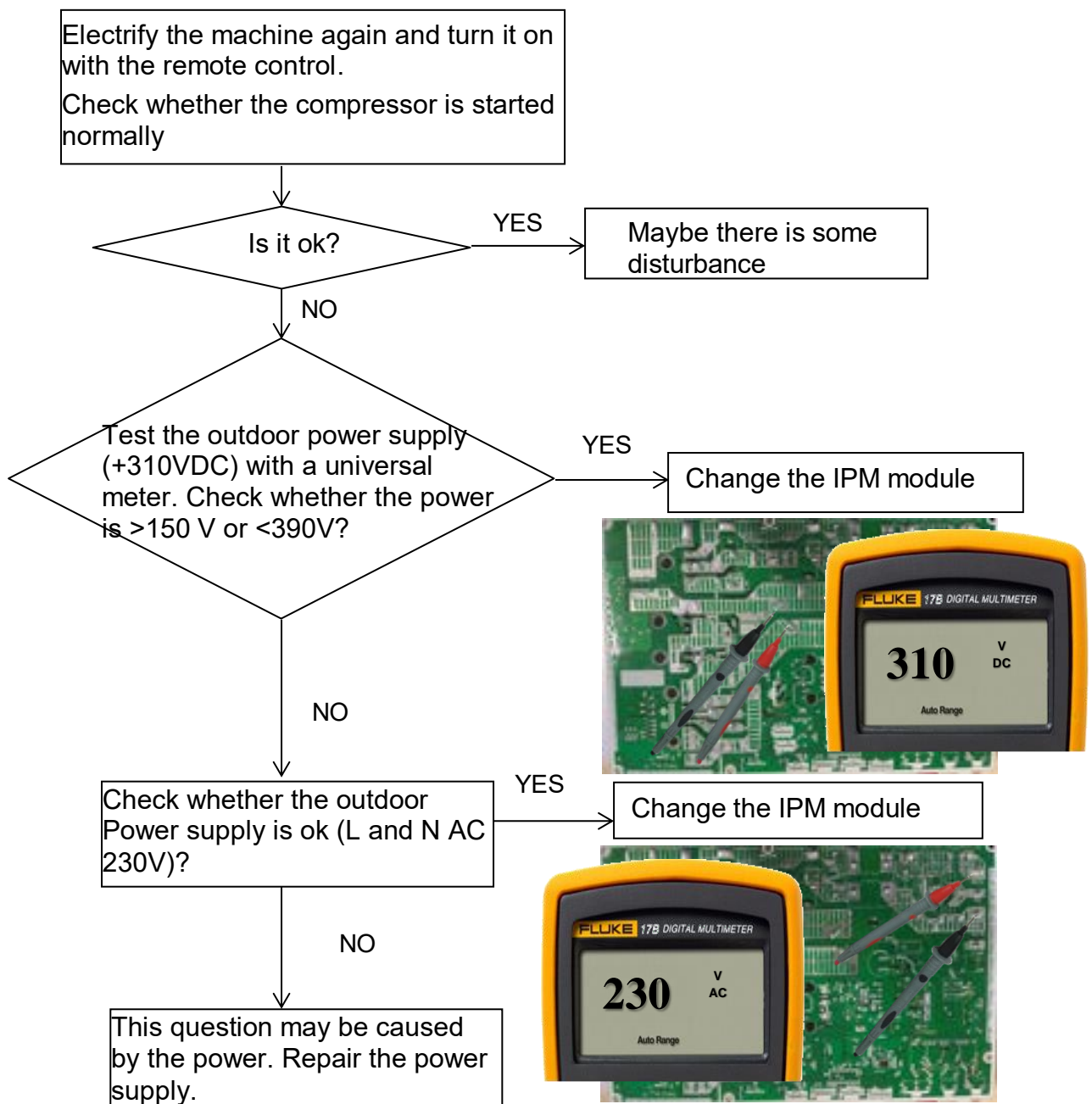

10.4.9 Overheat Protection for Discharge Temperature

Outdoor display: F4 LED1 flash 8 times

Method of Malfunction Detection	Check the control of the discharge temperature by the temperature detected by the discharge pipe thermistor
Malfunction Decision Conditions	When the compressor discharge temperature is above 110°C
Supposed Causes	<ul style="list-style-type: none"> ■ Electronic expansion valve defective ■ Faulty thermistor ■ Faulty PCB
Trouble shooting	* Caution: Be sure to turn off power switch before connect or disconnect connector or else parts damage may be occurred.

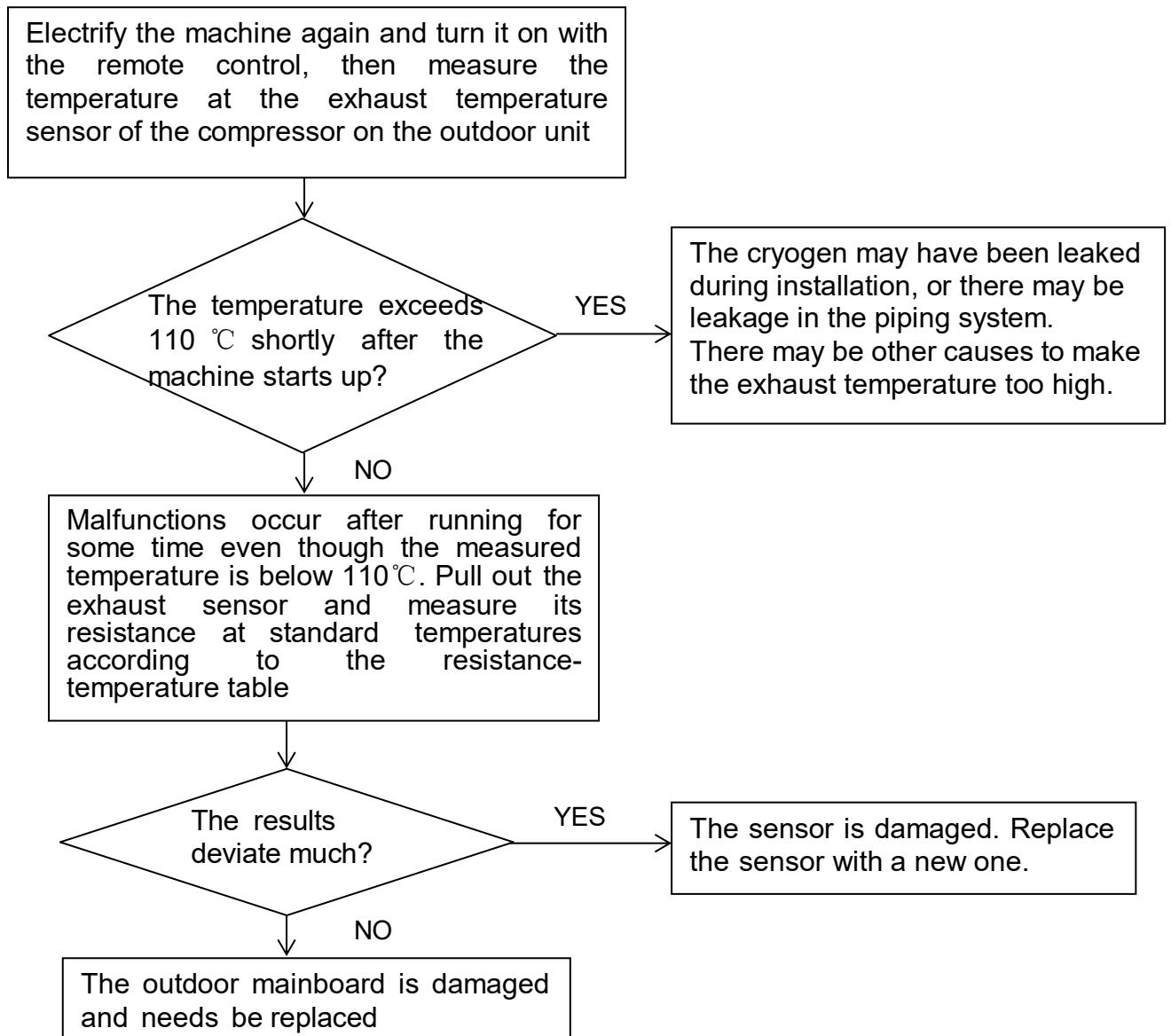

10.4.10 The communication fault between indoor and outdoor

Split board Indoor display E7 outdoor display LED1 flash 15 times

Method of Malfunction Detection	Communication is detected by checking the indoor PCB and the outdoor PCB.
Malfunction Decision Conditions	The outdoor PCB broken leads to communication fault. The indoor PCB broken leads to communication fault.
Supposed Causes	<ul style="list-style-type: none"> ■ Communication wiring disconnected. ■ The indoor PCB is broken. ■ The outdoor PCB is broken. ■ The Power Module is broken.
Trouble shooting	* Caution: Be sure to turn off power switch before connect or disconnect connector, or else parts damage may be occurred.

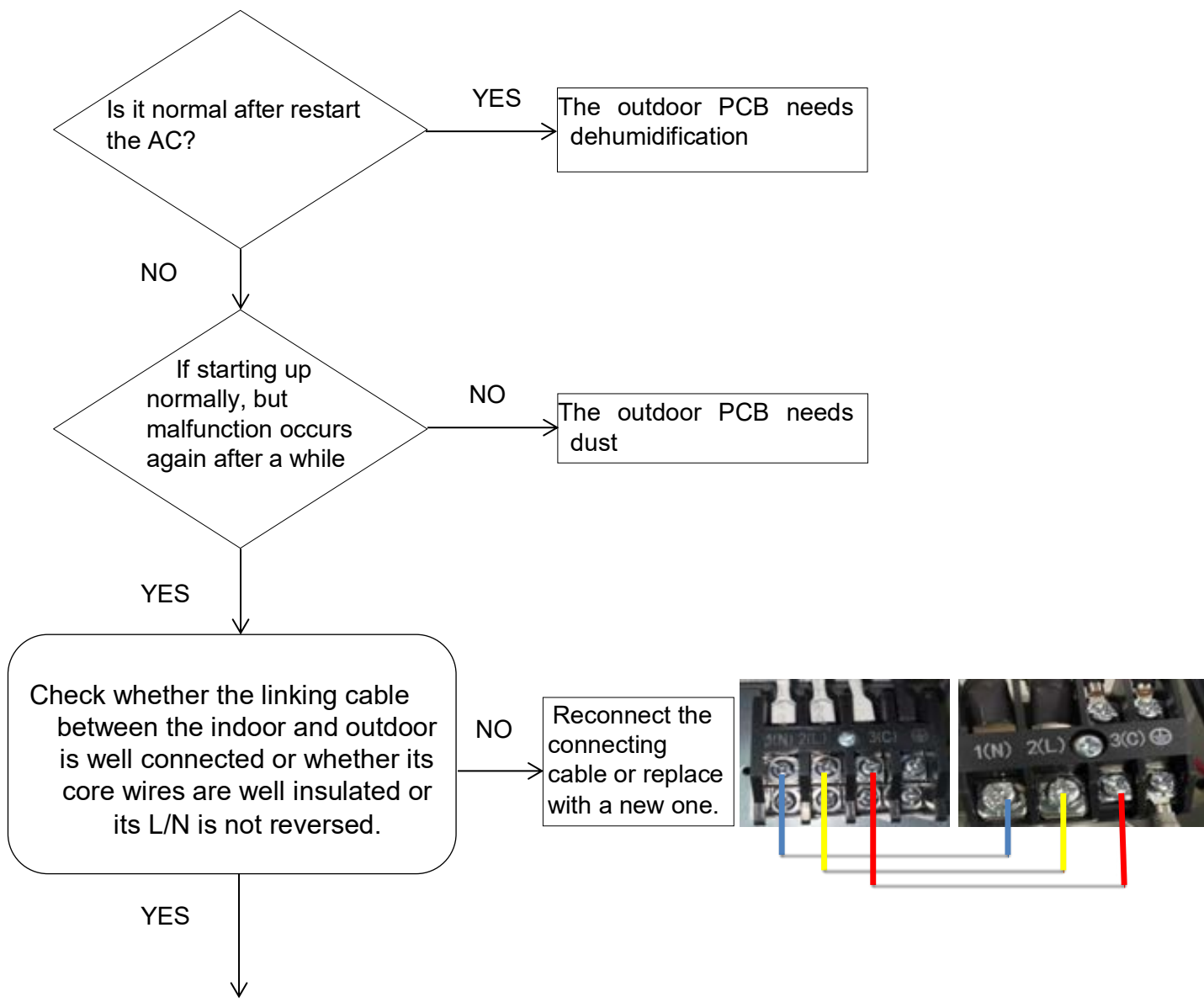

Check the indoor PCB: only indoor charged measure the voltage between 3 and 4 of IC6 on the indoor PCB with a universal meter. And measure the voltage between CN23(S) and CN17 (L) with a universal meter.

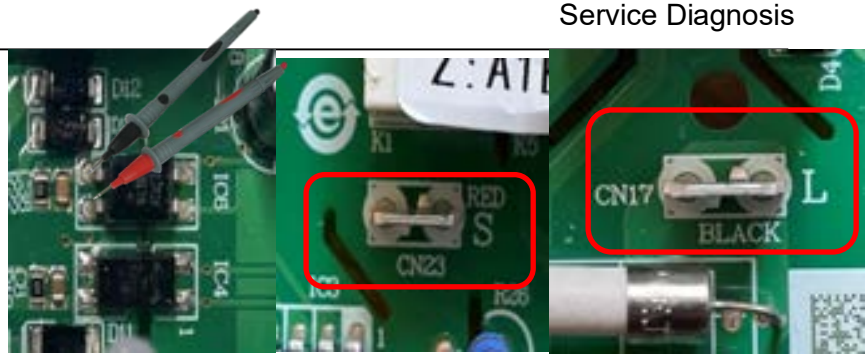

If the voltage is a constant value from DC 0V to DC 5V. Or the voltage between communication line (red) and N (white line) is not close to 18V DC when only indoor charged.

YES
The indoor PCB is damaged; replace it with a new one.

NO

Test the outdoor power is supply 230VAC with a universal meter when indoor and outdoor are charged.

NO
Check the cable between outdoor and power



YES

LED2 light of the outdoor

NO
The module PCB is damaged. Replace it with a new one.



YES

LED 1 light

YES
Measure the voltage between 3 and 4 of IC9 on the Outdoor mainboard with a universal meter. The voltage is a constant value of 0V DC to 5V DC

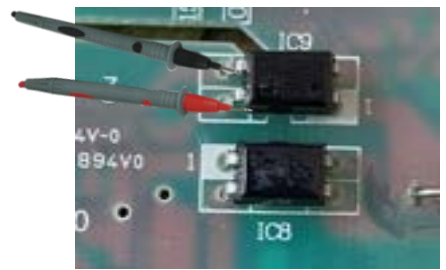

YES
The outdoor PCB is damaged. Replace it with a new one.

NO
Outdoor PCB is ok then check cable.

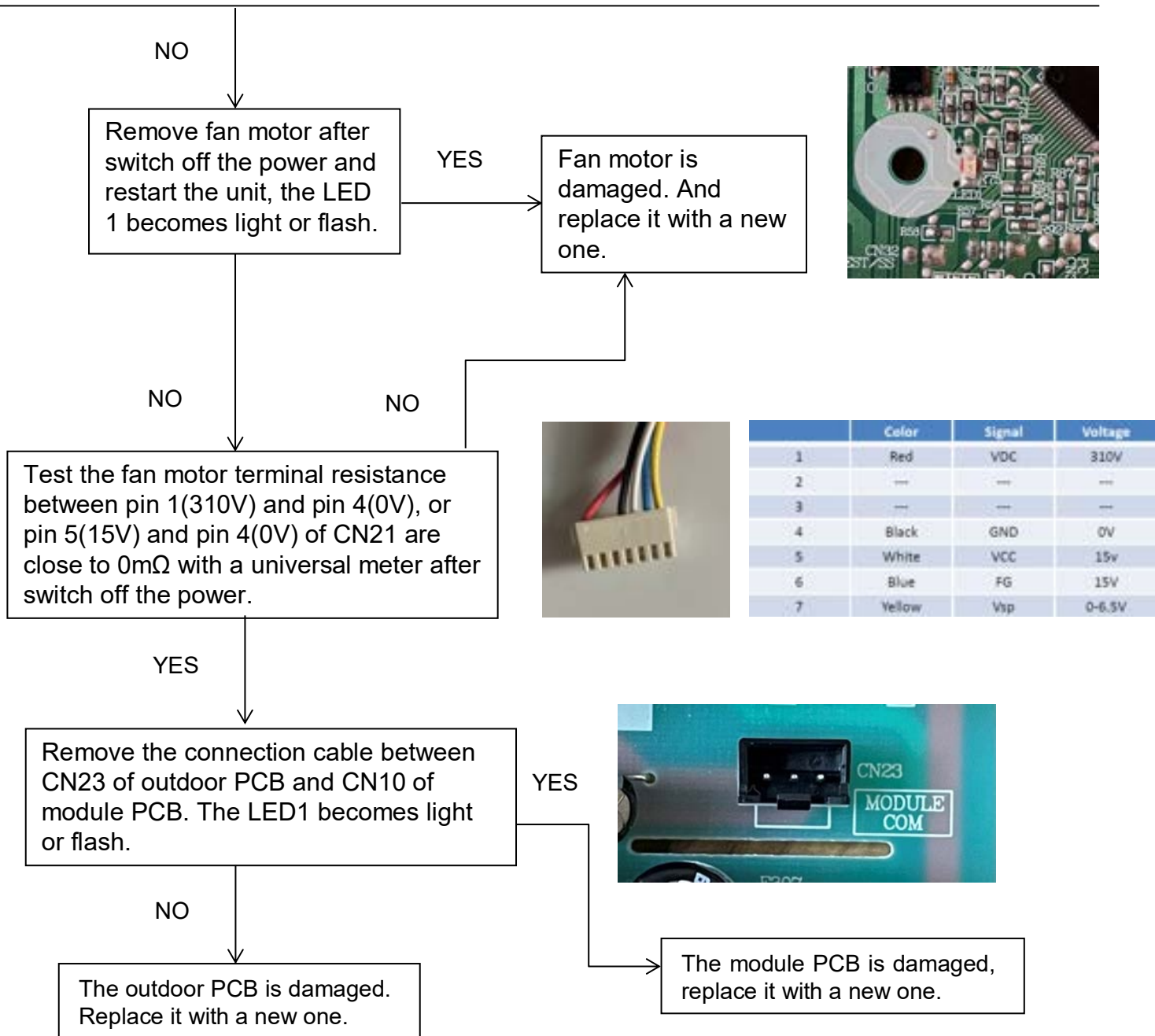

All-in-one board Indoor display E7 outdoor display LED2 flash 15 times

Method of Malfunction Detection	Communication is detected by checking the indoor PCB and the outdoor PCB.
Malfunction Decision Conditions	<ul style="list-style-type: none"> ■ The outdoor PCB broken leads to communication fault. ■ The indoor PCB broken leads to communication fault.
Supposed Causes	<ul style="list-style-type: none"> ■ Communication wiring disconnected. ■ The indoor PCB is broken. ■ The outdoor PCB is broken.
Trouble shooting	* Caution: Be sure to turn off power switch before connect or disconnect connector, or else parts damage may be occurred.

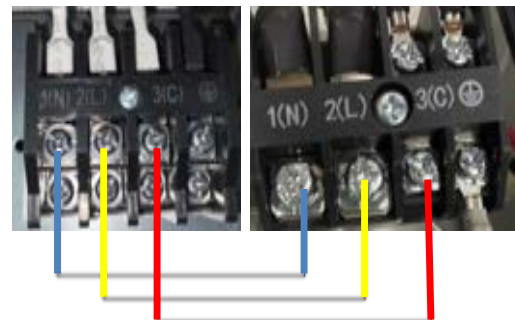
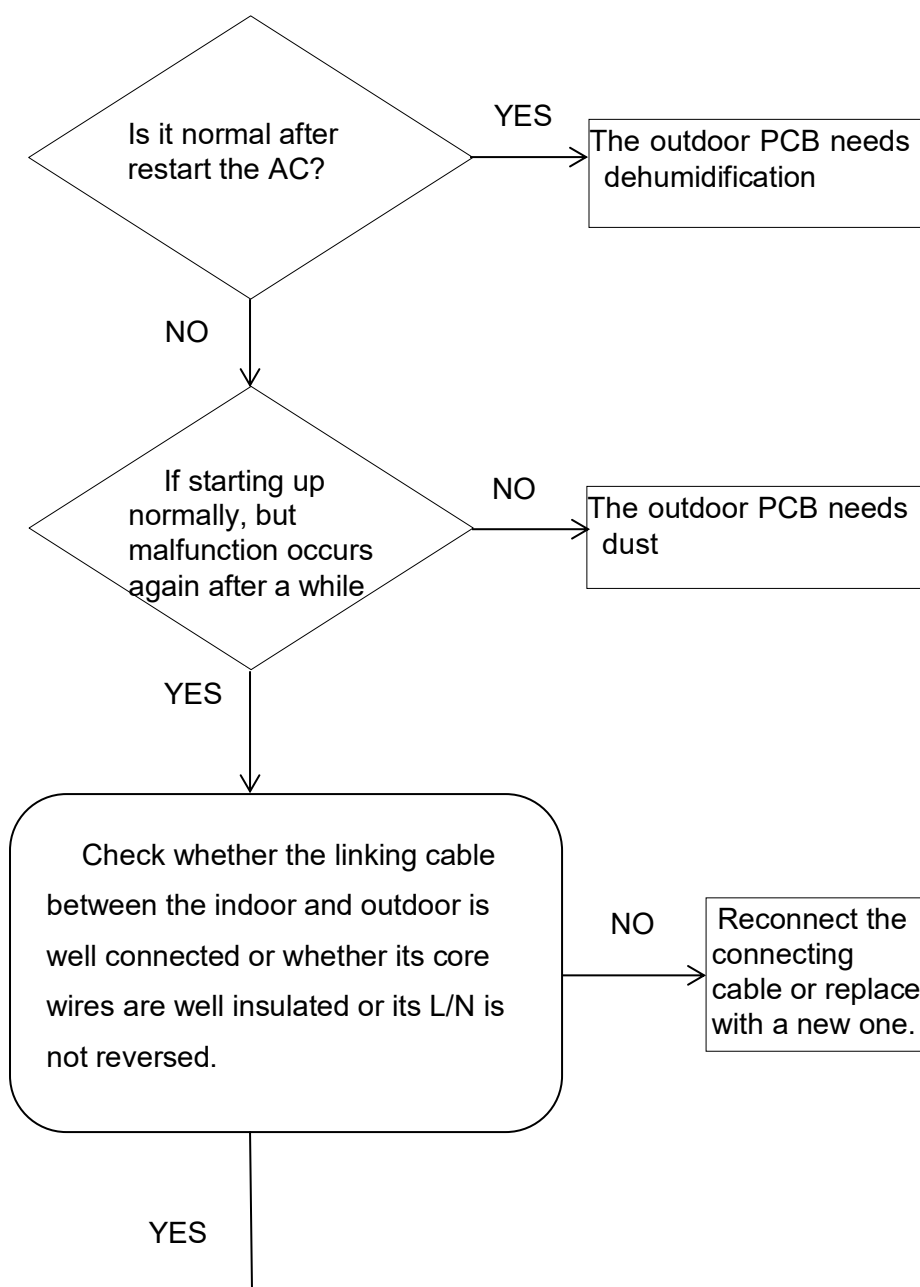

Check the indoor PCB: Only indoor charged measure the voltage between 3 and 4 of IC6 on the indoor mainboard with a universal meter. And measure the voltage between CN23(S) and CN52 (L) with a universal meter.

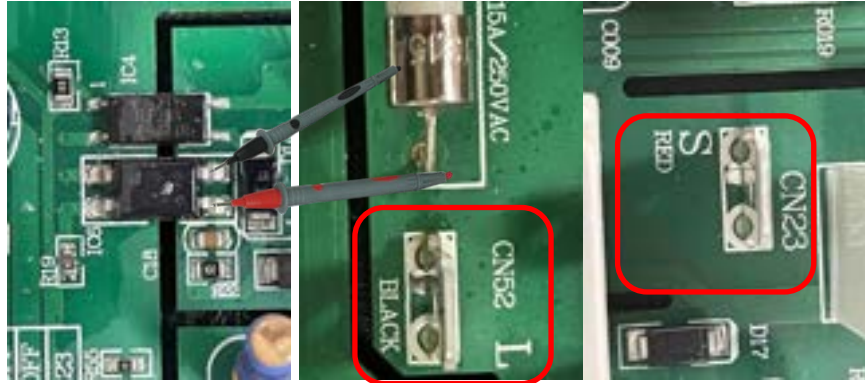

If the voltage is a constant value of 0V DC to 5V DC .Or the voltage between communication line (red) and N (white line) is not close to 18V DC when only indoor charged.

YES → The indoor PCB is damaged; replace it with a new one.

NO

Test the outdoor power is supply 230VAC with a universal meter when indoor and outdoor are charged.

NO → Check the cable between outdoor and power



YES

LED2 light

YES → Measure the voltage Between 3 and 4 of IC5 on the Outdoor mainboard with a universal meter. The voltage is a constant value of 0V DC to 5V DC

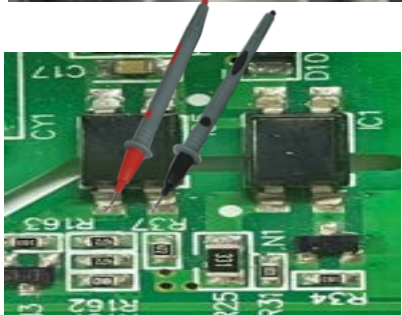

YES → The outdoor PCB is well, and then check the cable

NO → The outdoor PCB is damaged. Replace it with a new one.

NO

10.4.11 Loss of synchronism detection (Compressor position detection circuit fault)

Outdoor Display	F11 LED1 flash 18 times F28 LED1 flash 19 times
Method of Malfunction Detection	The position of the compressor rotor can't detected normally
Malfunction Decision Conditions	When the wiring of compressor is wrong or the connection is poor; Or the compressor is damaged
Supposed Causes	<ul style="list-style-type: none"> ■ Faulty The wiring of compressor ■ Faulty compressor ■ Faulty PCB
Trouble shooting	* Caution: Be sure to turn off power switch before connect or disconnect connector, or parts damage may be occurred.

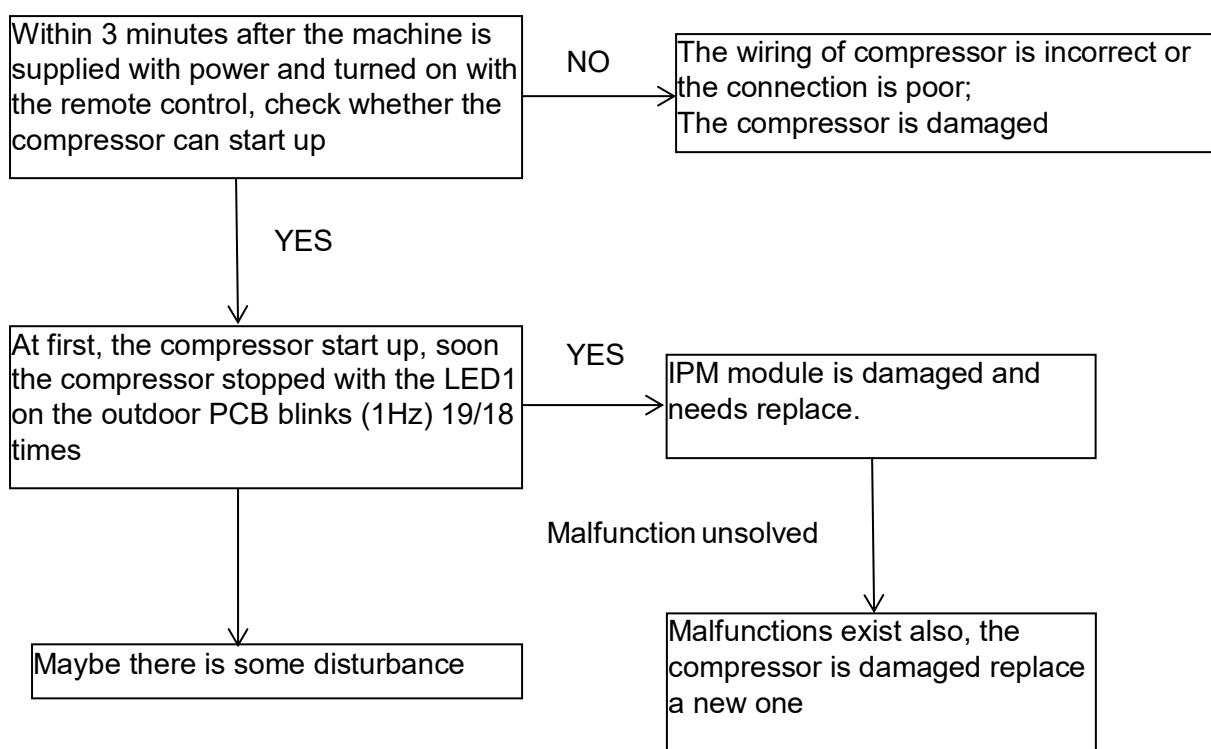

10.4.12 High work-intense protection

Outdoor display	E 9 LED1 flash 21 times
Method of Malfunction Detection	High work-intense control is activated in the heating mode if the temperature being sensed by the heat exchanger thermistor exceeds the limit.
Malfunction Decision Conditions	Activated when the temperature being sensed by the heat exchanger rises above 65°C twice in 30 minutes
Supposed Causes	<ul style="list-style-type: none"> ■ Faulty electronic expansion valve ■ Dirty heat exchanger ■ Faulty heat-exchange sensor ■ Insufficient gas
Trouble shooting	<p>* Caution: Be sure to turn off power switch before connect or disconnect connector, or parts damage may be occurred.</p>

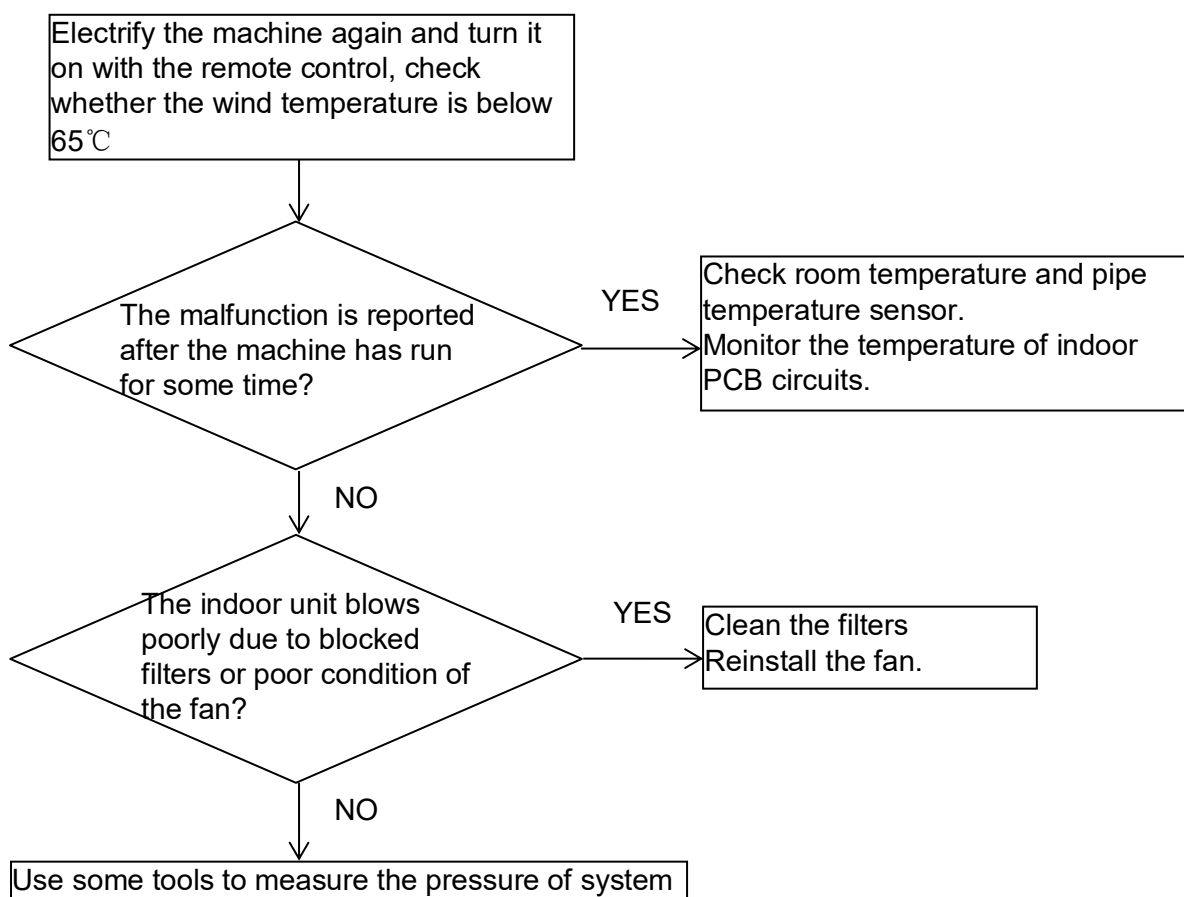

11. Performance and curves diagrams

11.1 Cooling capacity-temperature curves

performance curves											
cooling value-temperature table											
indoor temp.											
DB/WB	-10°C	0°C	8°C	15°C	20°C	25°C	30°C	35°C	38°C	40°C	43°C
21/15°C	1942	1971	2079	2084	2207	2239	2380	2593	2557	2479	2334
24/16°C	2175	2252	2320	2354	2516	2534	2751	2994	2951	2770	2619
27/19°C	2394	2496	2530	2574	2710	2764	2985	3302	3205	3035	2853
30/22°C	2763	2860	2925	2990	3120	3185	3413	3738	3640	3510	3283
32/23°C	2913	3052	3150	3210	3351	3389	3667	3911	3903	3718	3427
35/24°C	3066	3131	3171	3293	3384	3549	3707	4129	3968	3827	3669

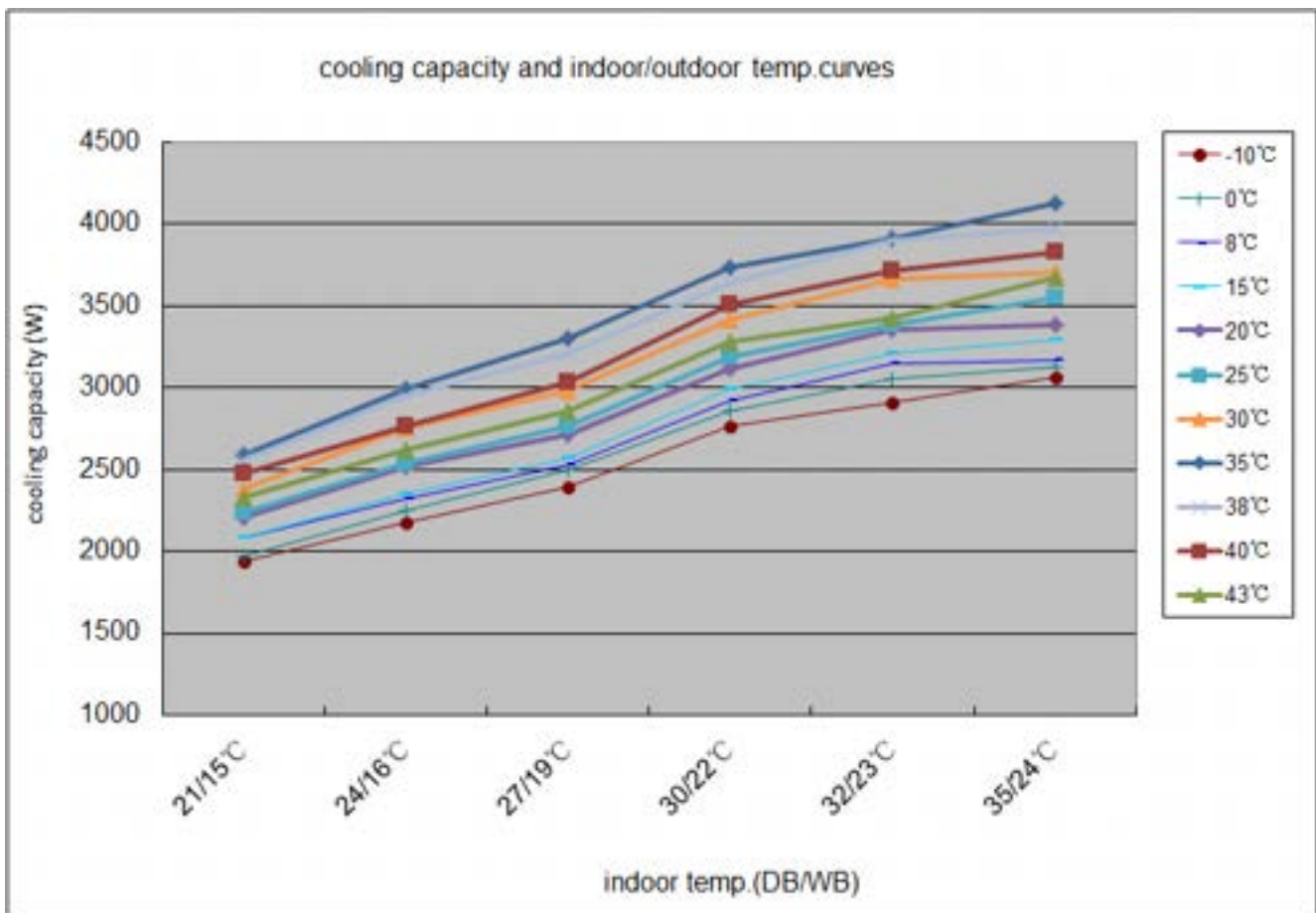

11.2 Cooling power consumption value- temperature curves

performance curves											
power consumption value-temp.table											
indoor temp.	-10℃	0℃	8℃	15℃	20℃	25℃	30℃	35℃	38℃	40℃	43℃
21/15℃	498	529	549	577	633	652	716	817	781	821	789
24/16℃	567	594	625	671	710	738	825	923	876	944	913
27/19℃	617	644	681	706	777	807	888	994	1013	1024	1017
30/22℃	699	743	780	819	879	923	1019	1154	1159	1155	1116
32/23℃	742	784	821	856	942	973	1094	1228	1212	1234	1181
35/24℃	770	820	863	895	964	1005	1117	1271	1270	1282	1230

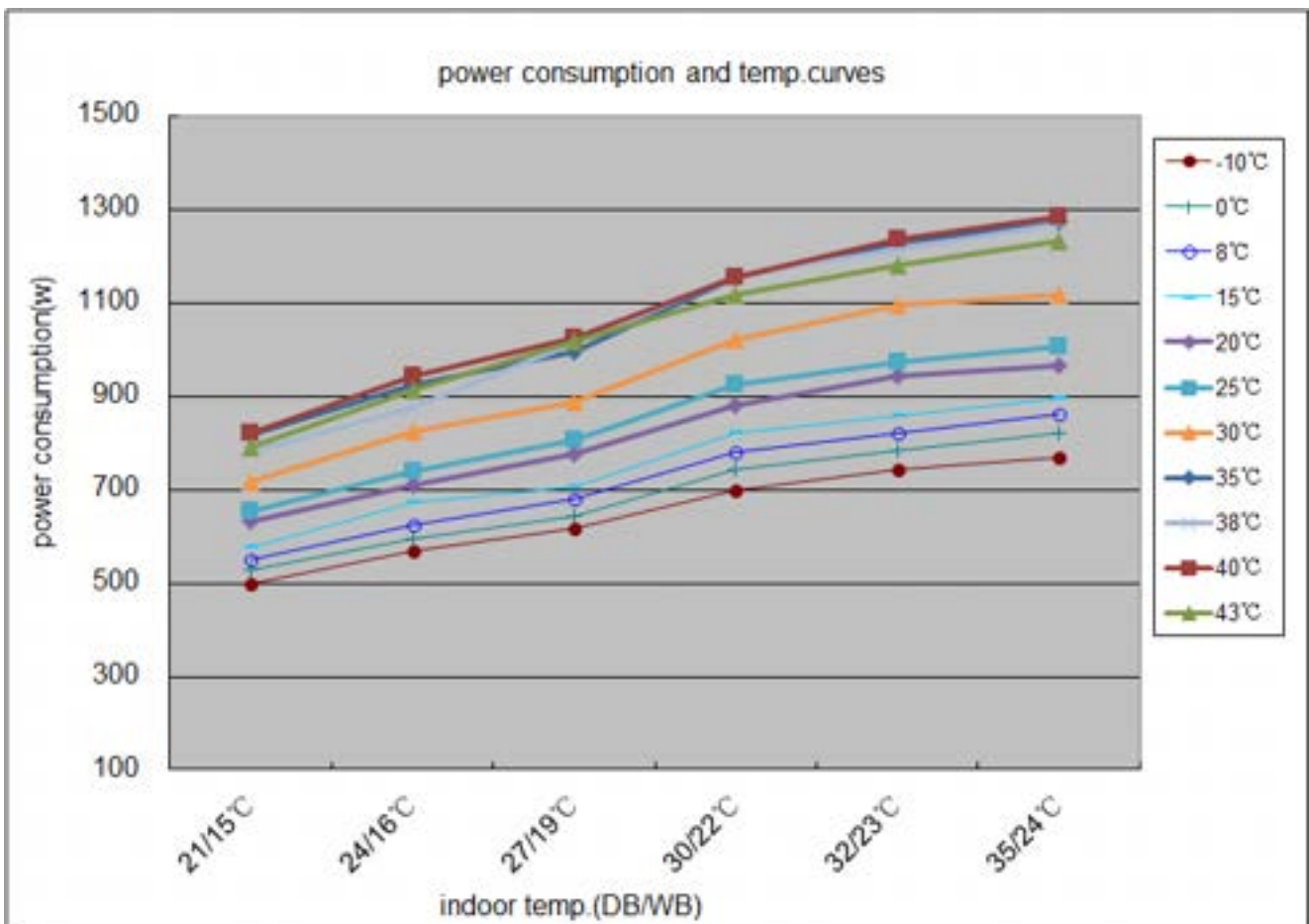

11.3 Cooling discharge pressure curves

performance curves			
cooling discharge pressure.table			
outdoor temp. (humidity 46%)	indoor temp.		
DB/WB	21/15°C	27/19°C	35/24°C
-10°C	1348	1420	1470
0°C	1536	1578	1672
8°C	1630	1710	1822
15°C	1746	1841	1946
20°C	1946	2025	2126
25°C	2100	2157	2251
30°C	2174	2341	2457
35°C	2428	2499	2648
38°C	2594	2683	2791
40°C	2904	3025	3128
43°C	3242	3419	3598

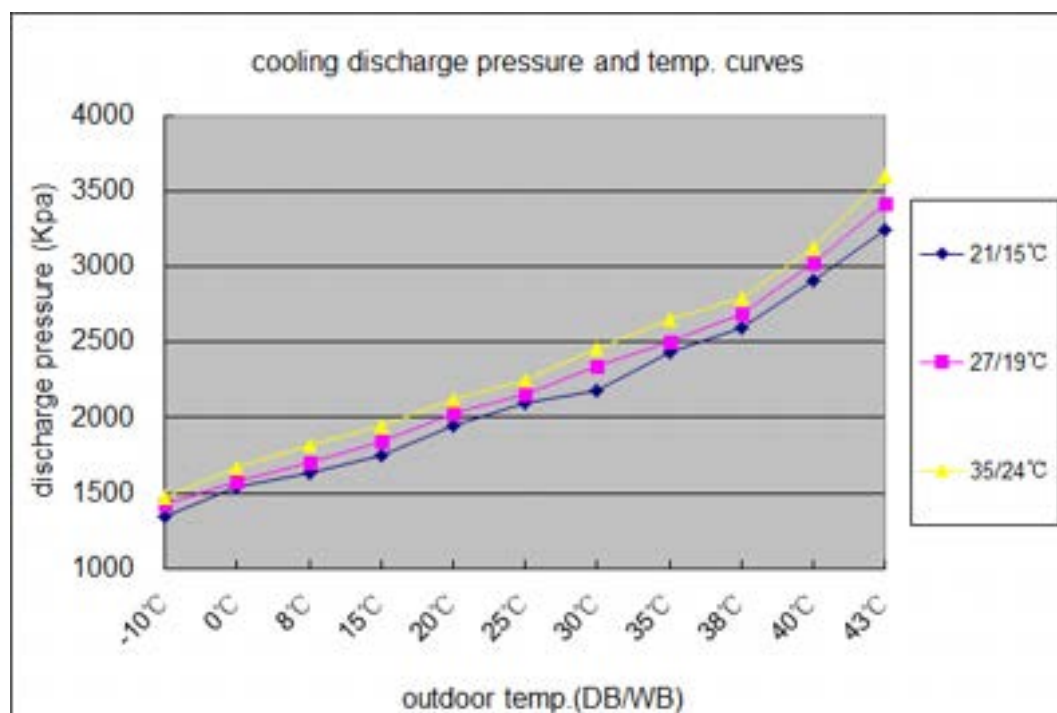

11.4 Cooling suction pressure curves

performance curves			
cooling suction pressure.table			
outdoor temp. (humidity 46%)	indoor temp.		
DB/WB	21/15°C	27/19°C	35/24°C
-10°C	653	805	925
0°C	680	838	964
8°C	701	864	994
15°C	716	882	1014
20°C	723	891	1024
25°C	761	900	1045
30°C	801	947	1056
35°C	843	956	1111
38°C	887	986	1134
40°C	976	1085	1247
43°C	1074	1171	1360

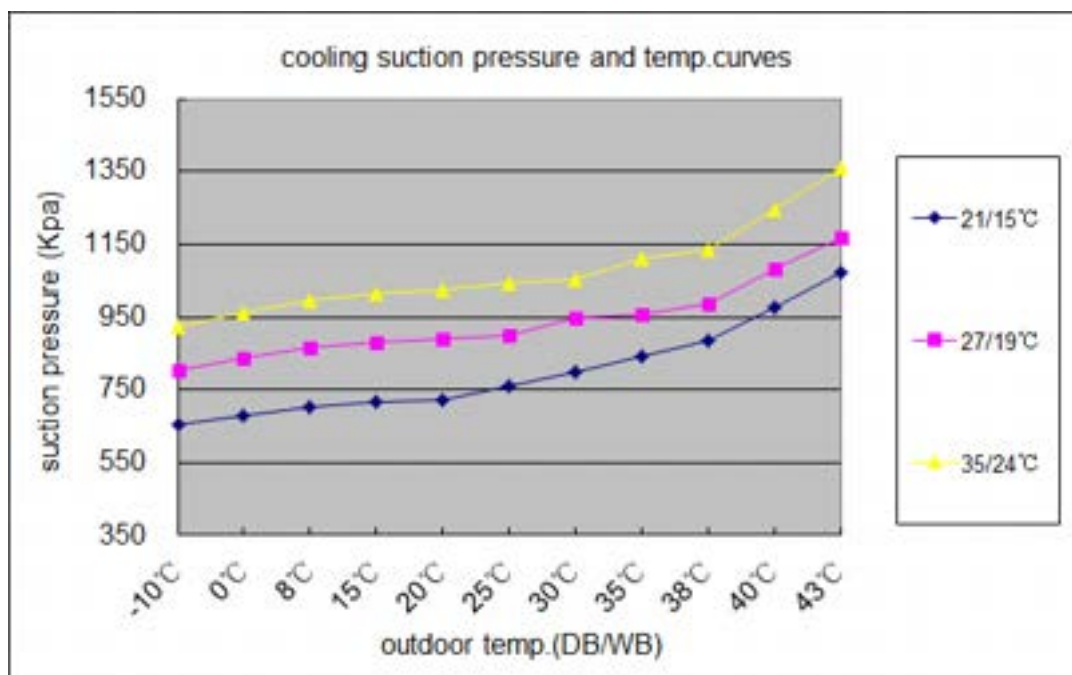

11.5 Heating capacity-temperature curves

performance curves							
heating capacity and indoor/outdoor temp.table							
outdoor temp.	indoor temp.(humidity 46%)						
DB/WB	10°C	15°C	18°C	20°C	22°C	24°C	27°C
-15°C	2312	2259	2188	1955	2039	2010	1957
-10°C	2739	2668	2561	2439	2369	2334	2312
-7/-8°C	3279	3119	2992	2930	2899	2684	2528
2/1°C	3513	3342	3153	3093	2973	2913	2853
7/6°C	3700	3638	3561	3515	3392	3299	3073
12/11°C	3303	3197	3143	3090	2930	2824	2572
18/16°C	3106	2991	2876	2761	2646	2531	2166
24/20°C	2615	2518	2422	2325	2228	2131	1925

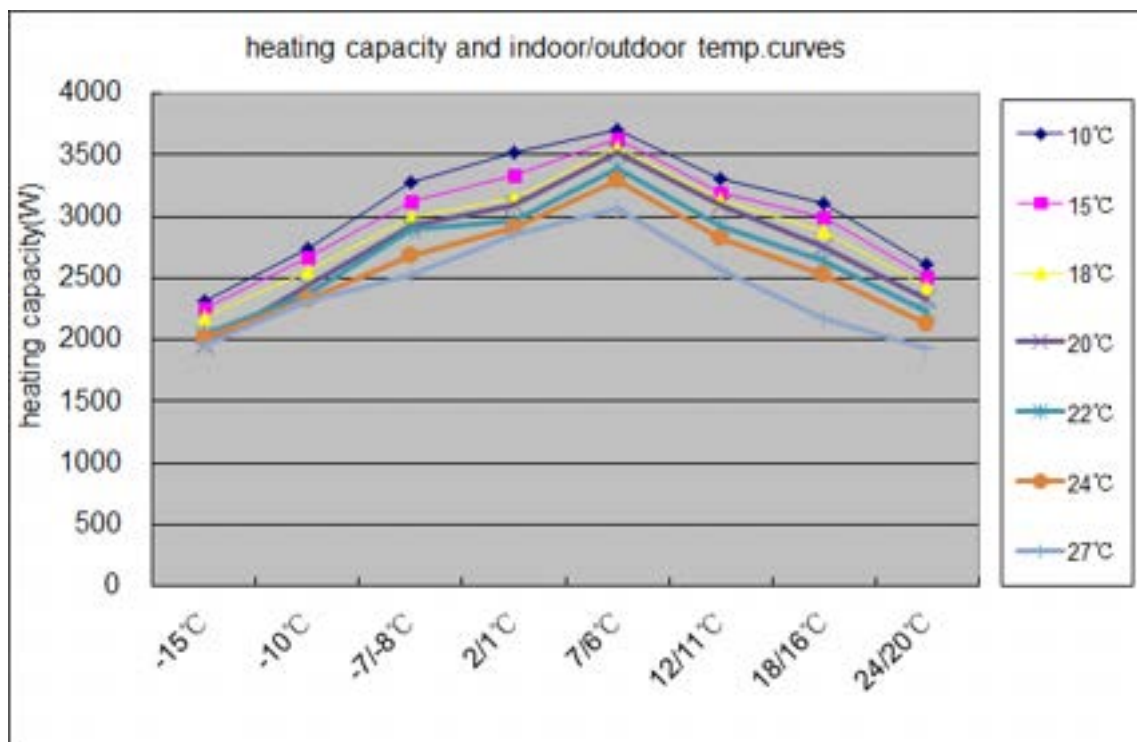

11.6 Heating power consumption value- temperature curves

performance curves							
power consumption value-temp.table							
outdoor temp.	indoor temp.(humidity 46%)						
DB/WB	10°C	15°C	18°C	20°C	22°C	24°C	27°C
-15°C	890	942	988	1023	1044	1064	1085
-10°C	950	971	1019	1056	1077	1098	1108
-7/-8°C	973	995	1043	1081	1103	1124	1114
2/1°C	925	915	960	995	1014	1034	1034
7/6°C	910	872	914	947	966	985	985
12/11°C	735	727	763	790	806	822	869
18/16°C	590	603	633	656	669	682	721
24/20°C	474	485	509	527	538	548	580

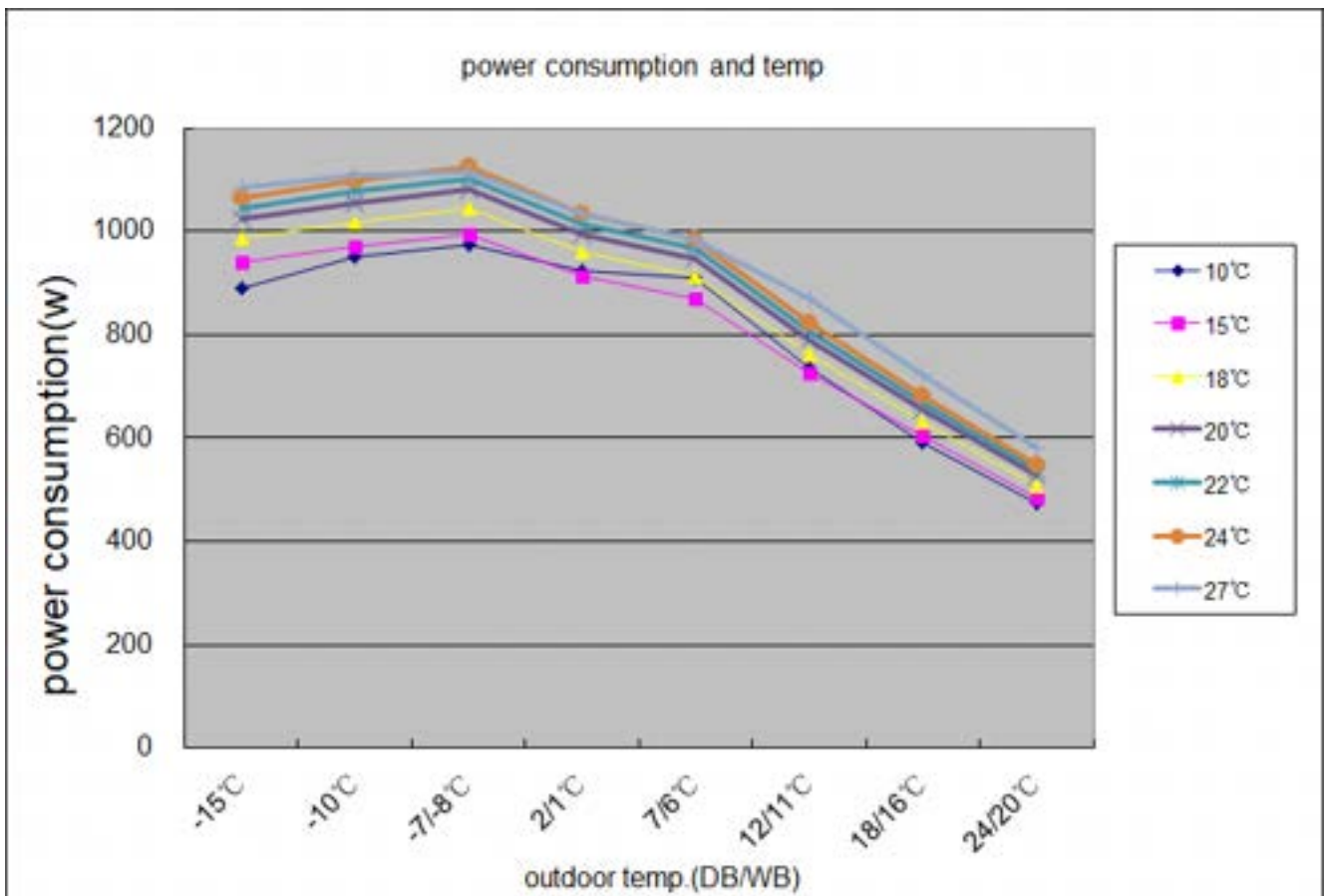

11.7 Heating discharge pressure curves

performance curves			
heating discharge pressure.table			
outdoor temp	indoor temp.		
DB/WB	10°C	20°C	27°C
-15°C	2540	2658	2743
-10°C	2944	3062	3198
-7/-8°C	3144	3344	3485
2/1°C	3396	3626	3766
7/6°C	3381	3520	3617
12/11°C	3163	3344	3515
18/16°C	2992	3143	3259
24/20°C	2544	2672	2804

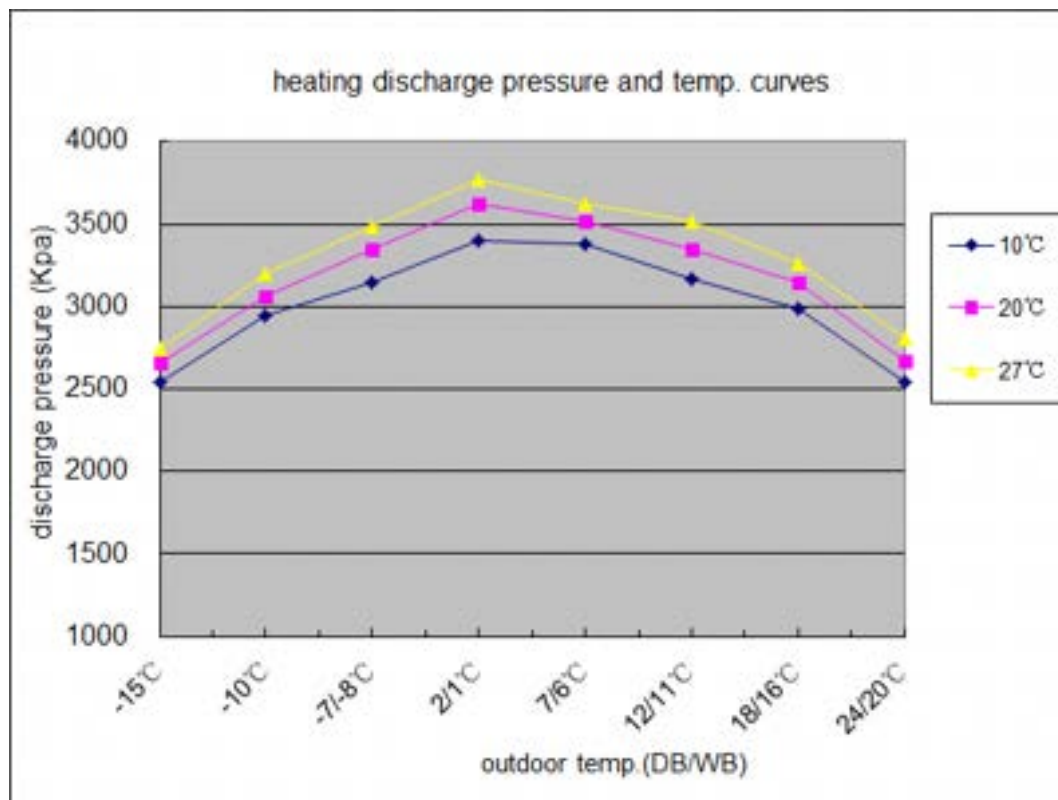

11.8 Heating suction pressure curves

performance curves			
heating suction pressure.table			
outdoor temp	indoor temp.		
DB/WB	10°C	20°C	27°C
-15°C	399	399	416
-10°C	449	449	466
-7/-8°C	519	553	570
2/1°C	638	672	689
7/6°C	771	805	822
12/11°C	878	912	929
18/16°C	1045	1079	1096
24/20°C	1231	1265	1282

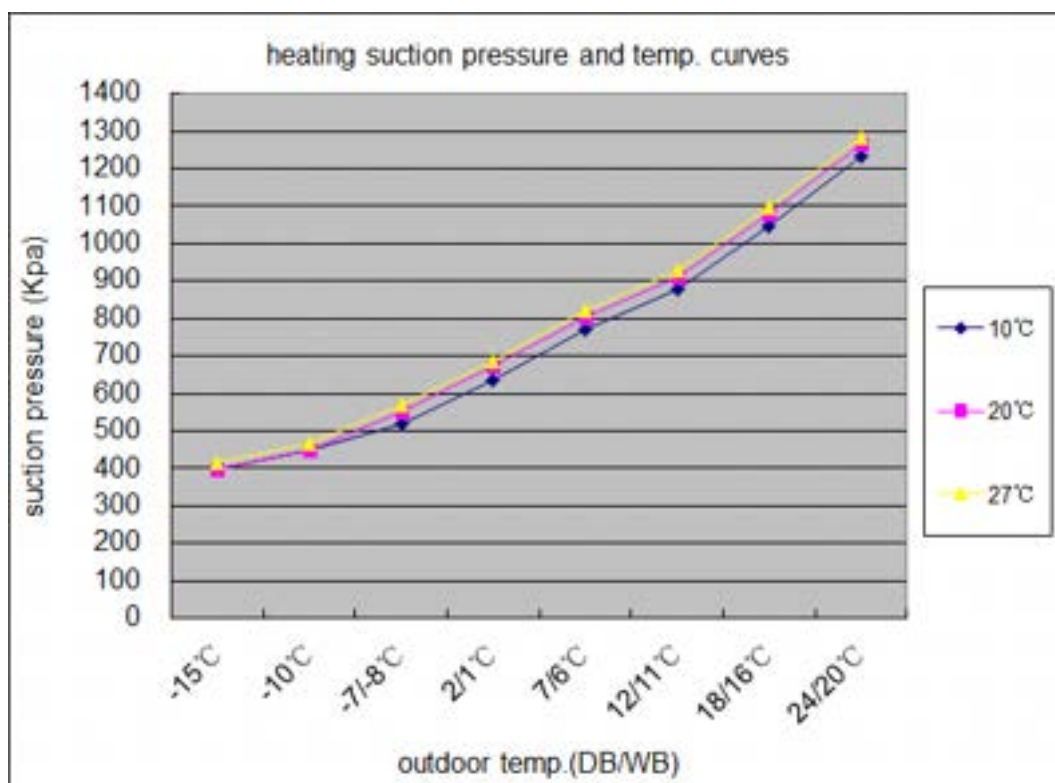

12. Circuit diagrams

12.1 Outdoor unit control board circuit diagrams

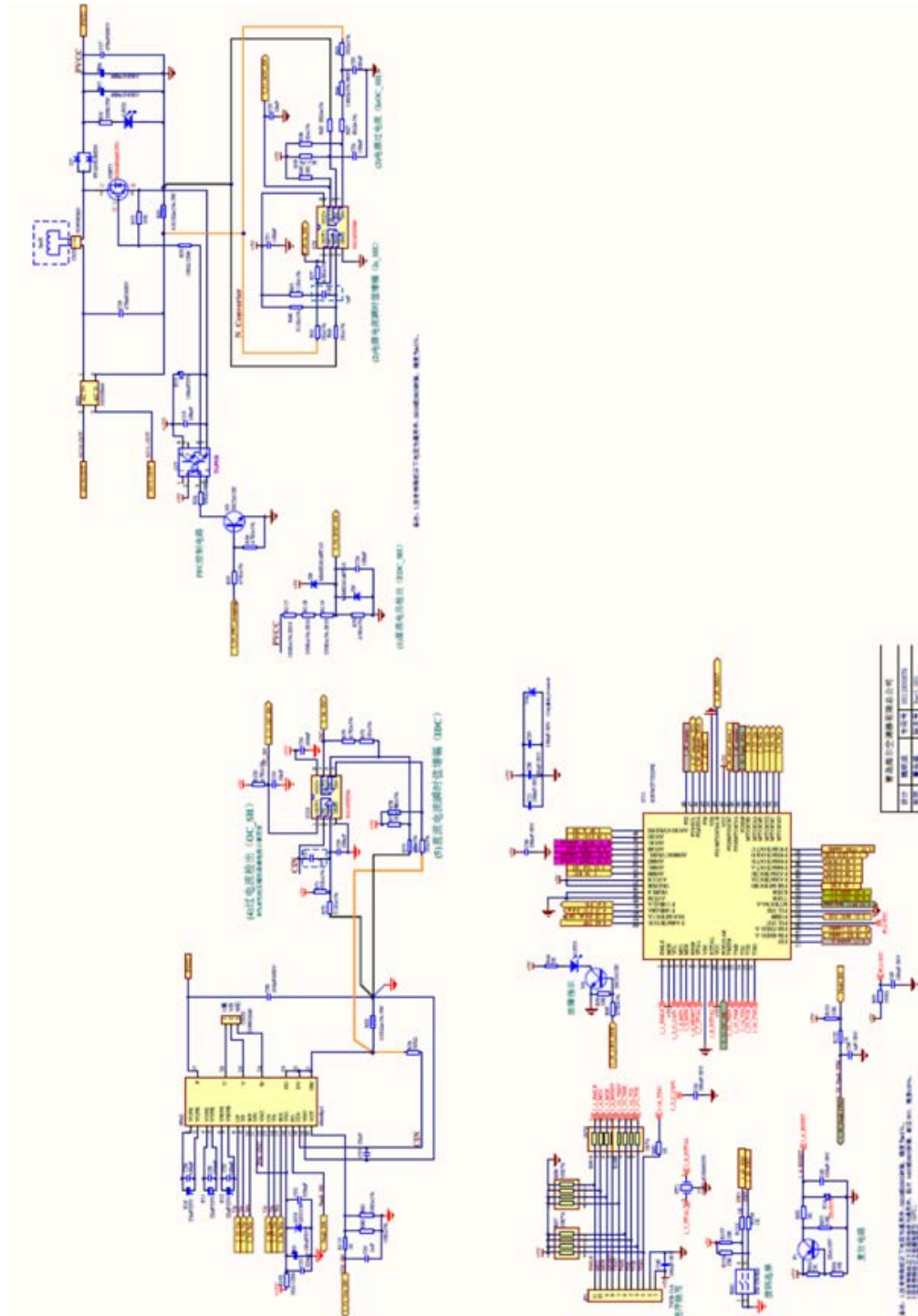

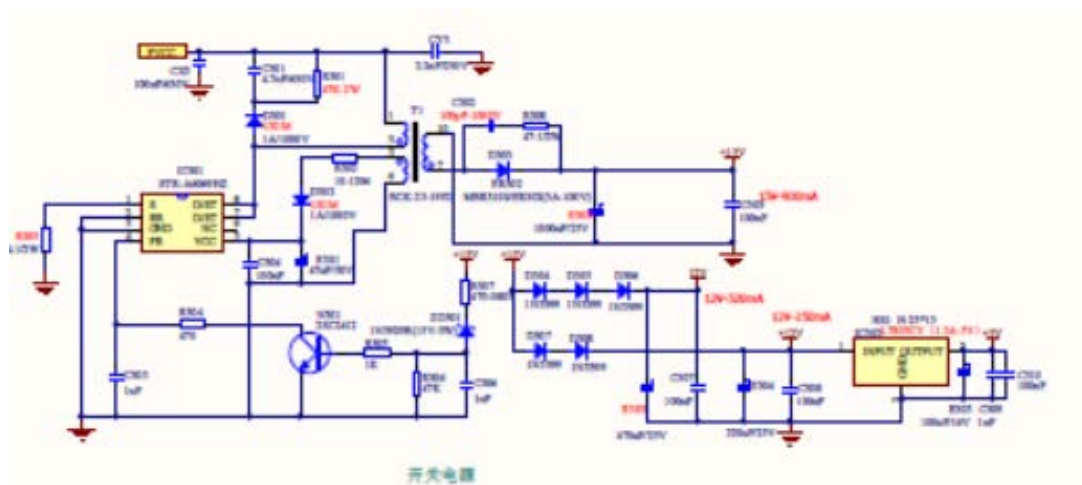
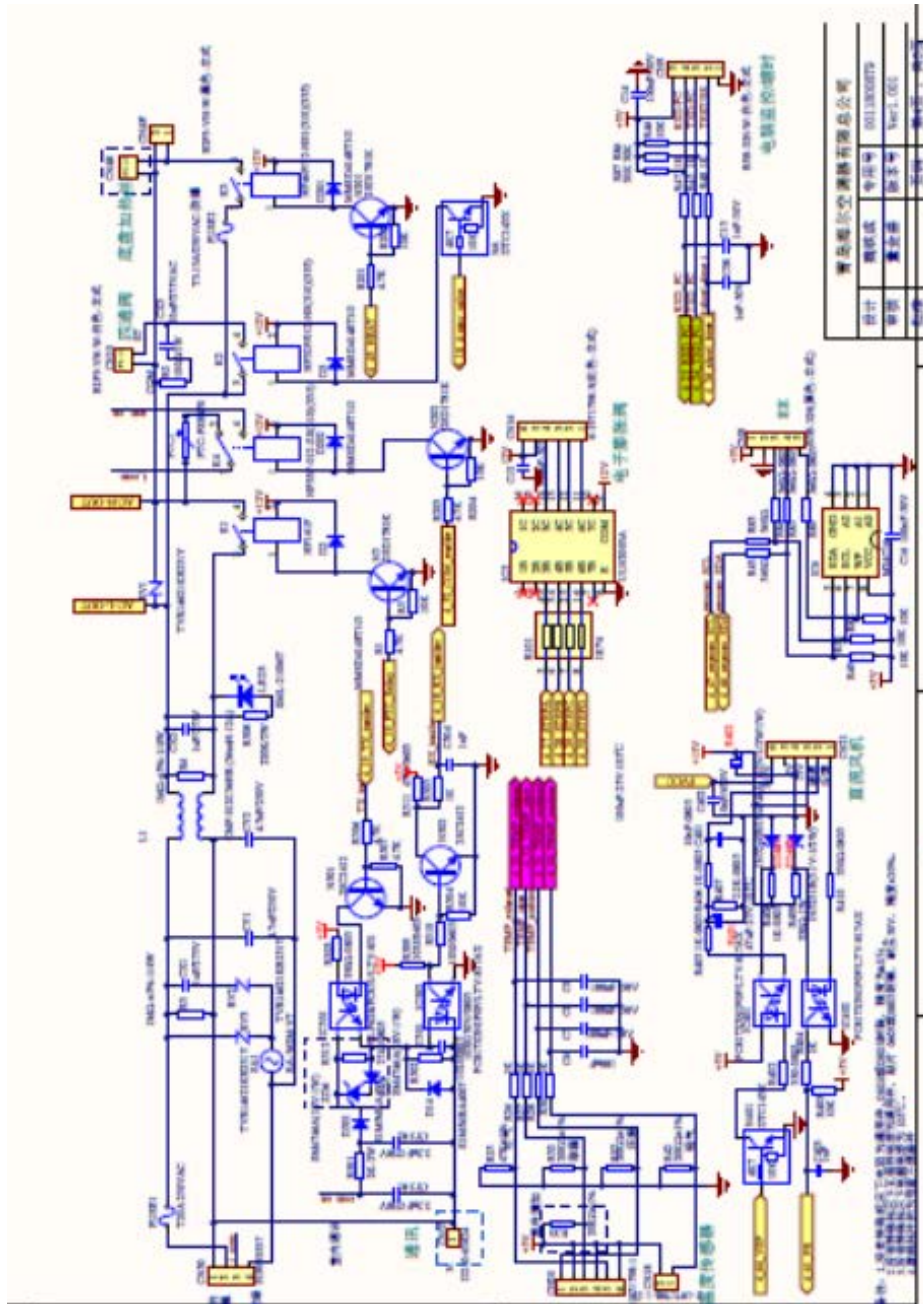

13. Removal Procedure

Removal of front panel

Outdoor unit

Procedure



Warning Be sure to wait 10 minutes or more after turning off all power supplies before disassembling work.

Step	Procedure	Points
1. Features		<ul style="list-style-type: none"> ■ Be careful not to cut your finger by the fins of the heat exchanger. ■ The stop valve cover is united with the shelter. ■ When assembling, make sure to fit the 5 hooks.
<p>1 Loosen the screw of the stop valve cover. Pull down the stop valve cover and remove it.</p>		

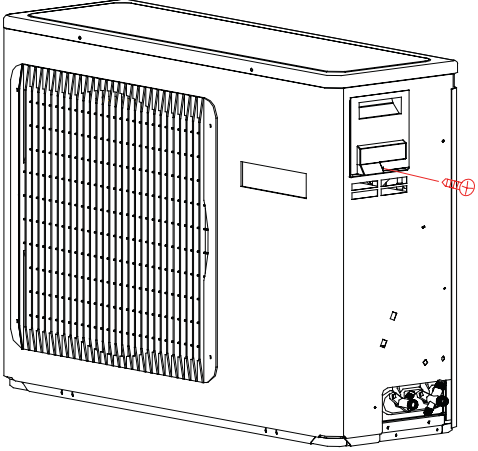
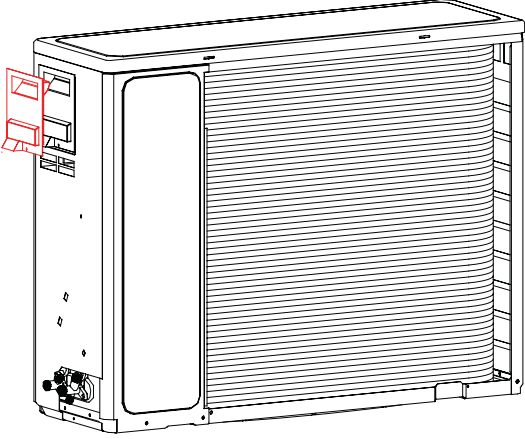
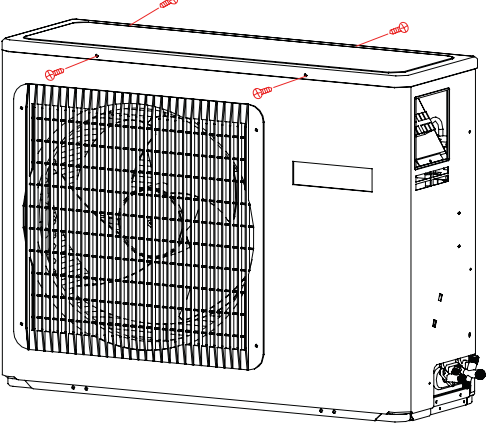
Step	Procedure	Points
2. Remove the panels.		
1	Loosen the service cover screw and remove the service cover.	
		
		
2	Loosen the 4 screws and lift the top panel	
		

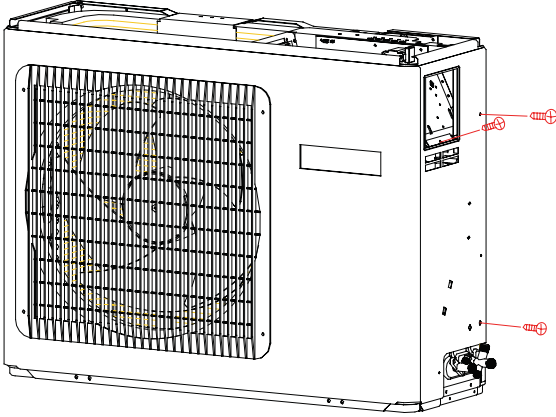
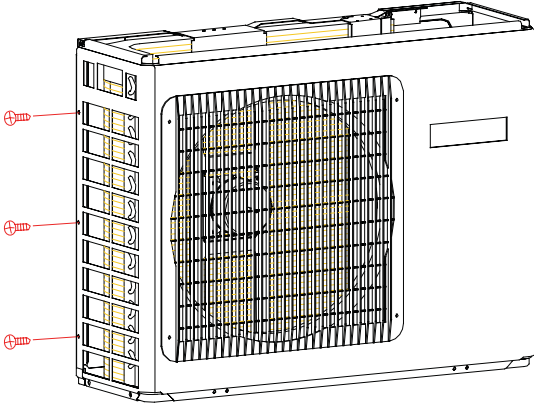
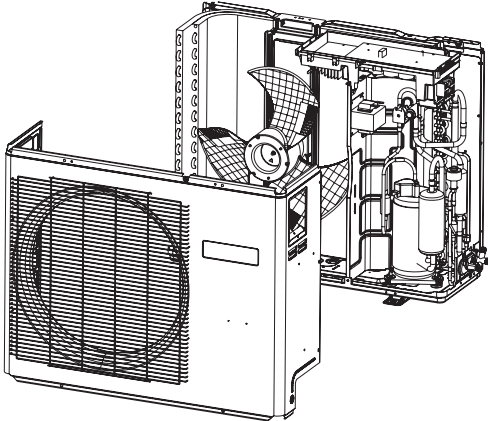
Step	Procedure	Points
	 	
3	Loosen the screws of the panel.	
4	Pull and remove the front panel.	

2. Removal of Electrical Box

Procedure

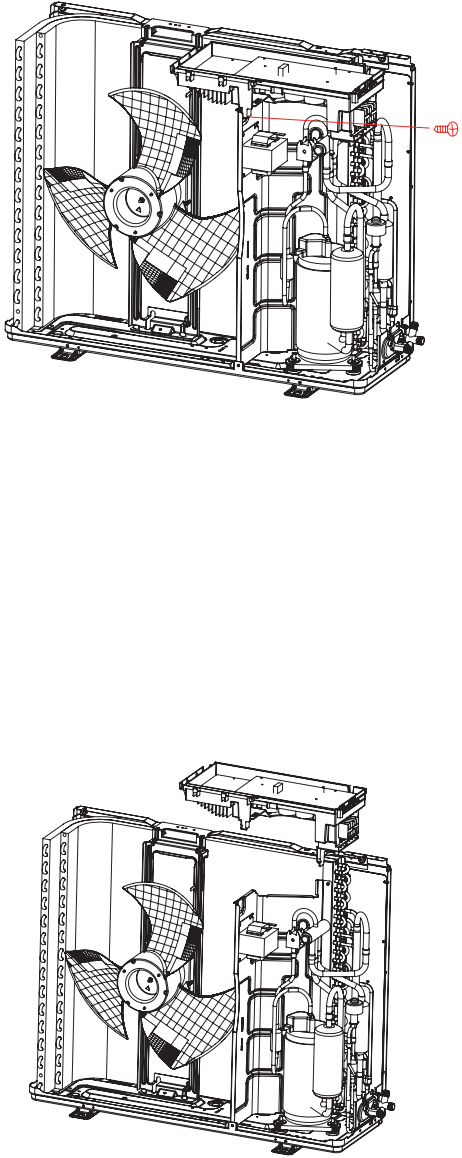

Warning Be sure to wait 10 minutes or more after turning off all power supplies before disassembling work.

Step	Procedure	Points
	<p>1 Remove the fixing screws Then lift the electrical box</p>	

3. Removal of Fan and Fan Motor

Procedure

 **Warning** Be sure to wait 10 minutes or more after turning off all power supplies before disassembling work.

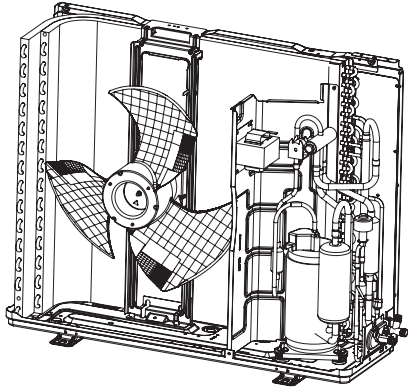
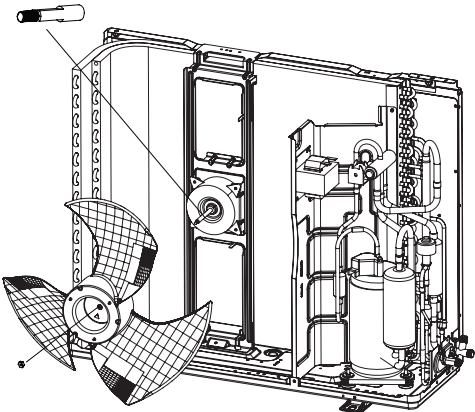
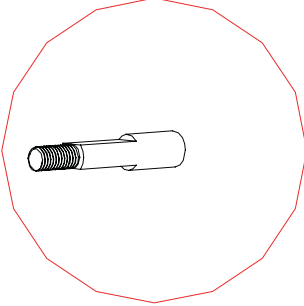
Step		Procedure	Points
1	Loosen the fixing screw and remove the fan	 	 <ul style="list-style-type: none"> ■ Put the lead wire through the back of the motor when assembling. (so as not to be entangled with the propeller fan)

4. Removal of fan motor bracket and partition

Procedure

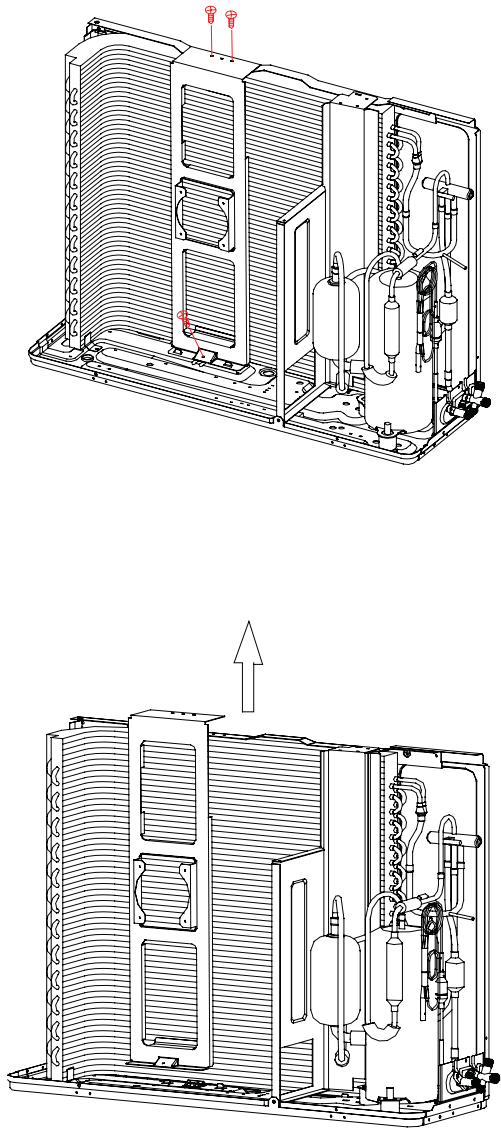

Warning Be sure to wait 10 minutes or more before disassembling work.

Step	Procedure	Points
<p>1</p>	<p>Loosen the fixing screws and lift the fan motor bracket.</p> 	

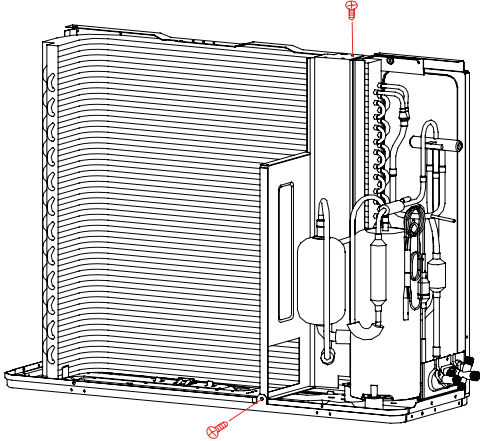
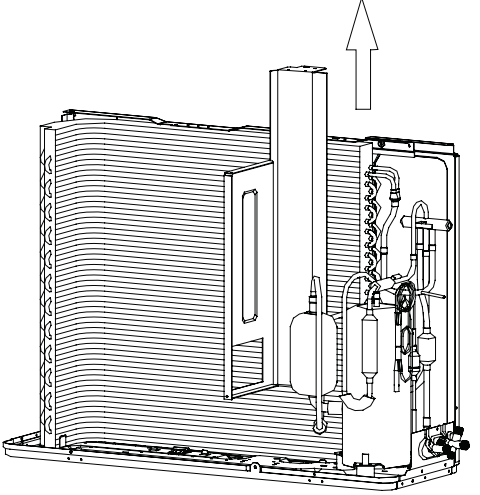
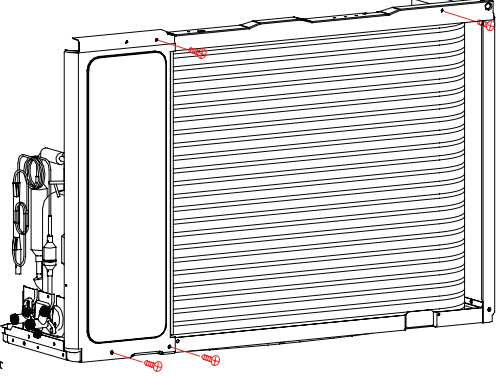
Step		Procedure	Points
3	Loosen the 2 screws		
4	The partition plate has a hook on the lower side. Lift and pull the partition plate to remove.		<ul style="list-style-type: none"> ■ When assembling ,fit the lower hook into the bottom frame .
5	Loosen the marked fixing screws		

5. Removal of compressor and heat exchanger

Procedure

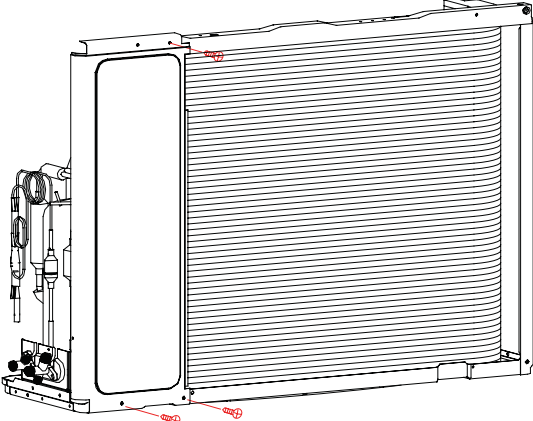
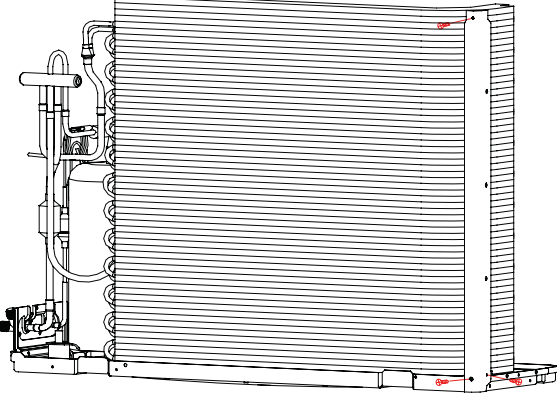
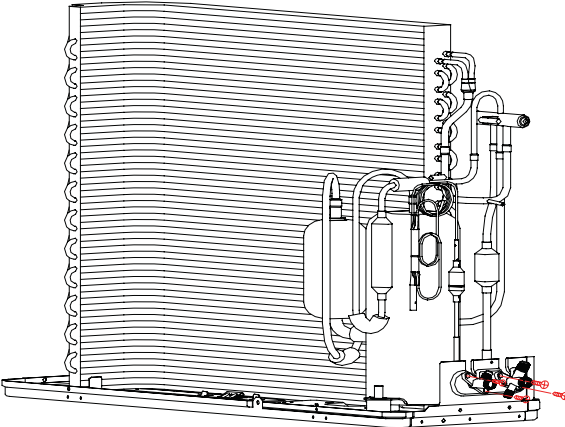

Warning Be sure to wait 10 minutes or more after tu before disassembling work.

Step	Procedure	Points
<p>1 Loosen the marked screw .</p>	 	
<p>2 Cut down the connecting pipe and pull out the compressor and remove the valve bracket .</p>		

Step	Procedure	Points
3	Loosen the marked fixing screw .	
4	Loosen the fixing hook and remove the heat exchanger .	

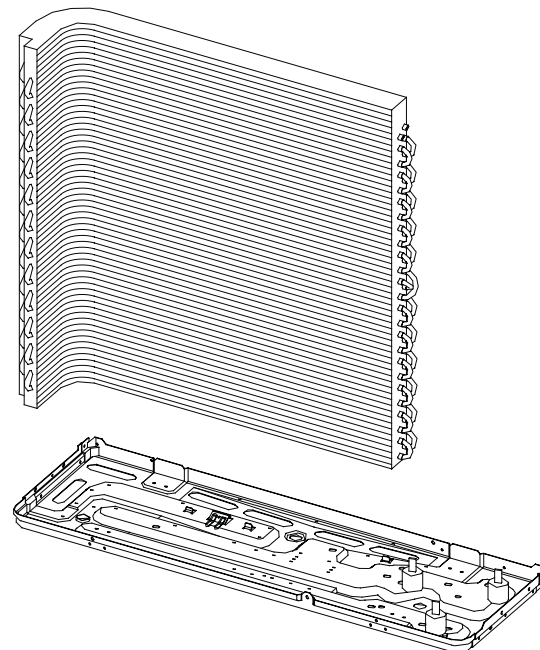
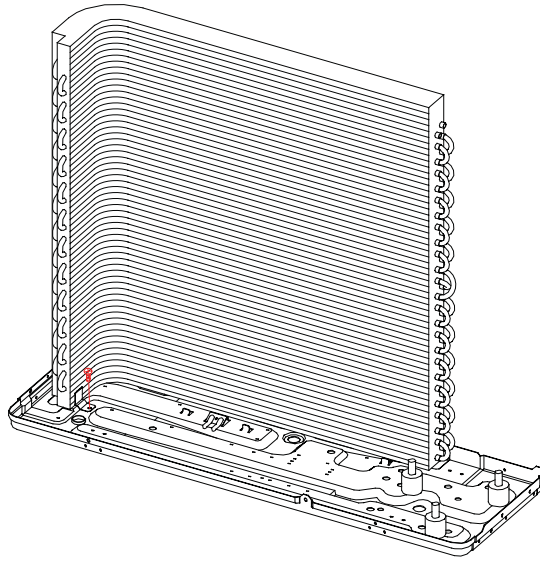

**Generalny Dystrybutor Systemów
Klimatyzacji i Pomp Ciepła HEIKO**

**IGLOTECH Sp. z o.o.
Ul. Toruńska 41, 82-500 Kwidzyn**

Tel. +48 782 887 887

www.heiko.pl